

MODEL

# ROCKETRY

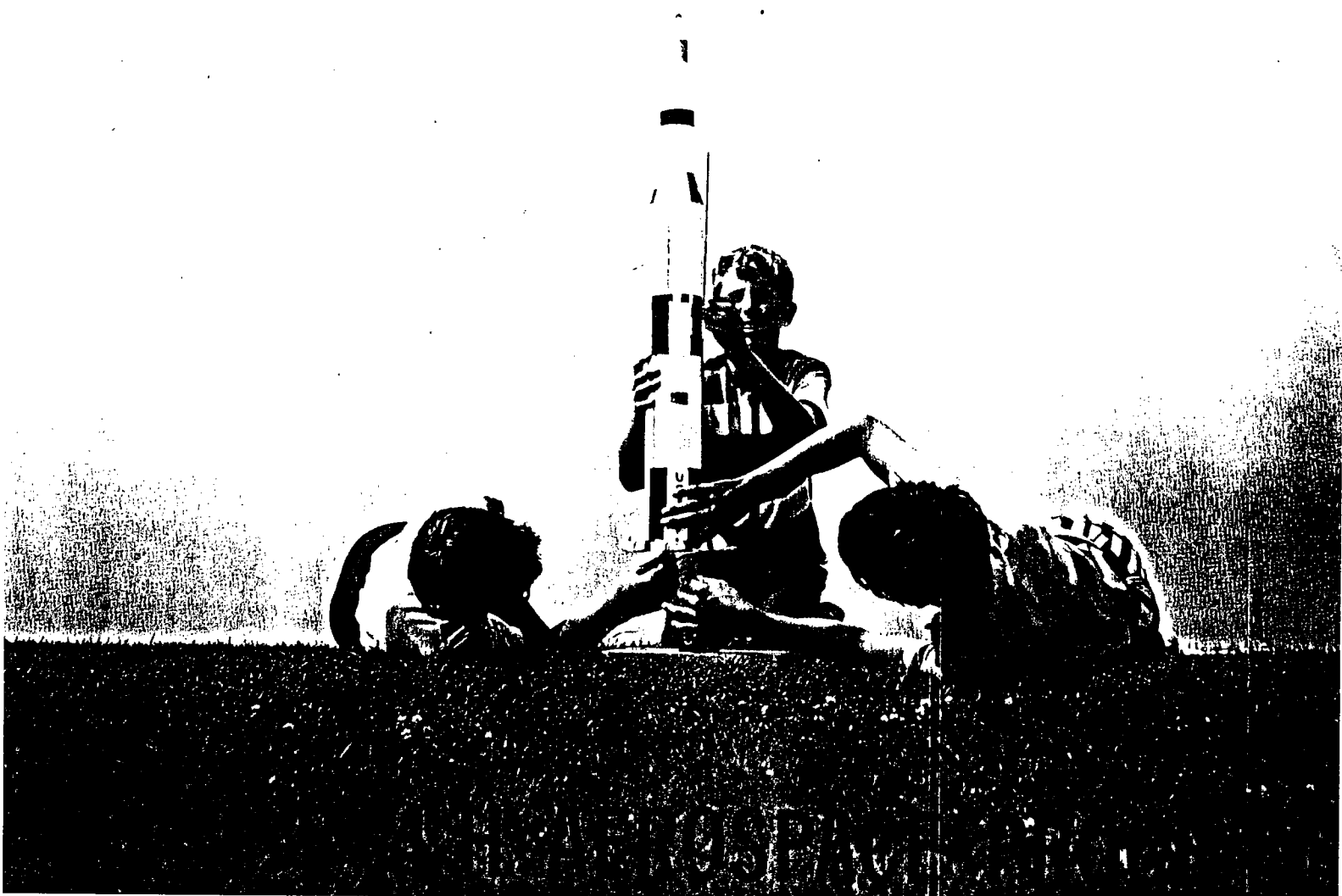

## **ACKNOWLEDGMENT**

This educational material has been prepared under the guidance of the National 4-H Aerospace Developmental Committee: E. L. Frickey, Indiana, chairman; Kemp Swiney, Extension Service USDA; Jerry Macklin, National 4-H Club Foundation; Ty Thompson, National 4-H Service Committee; Bill Shane, Idaho; Stanley Meinen, Minnesota; Jesse James, New Hampshire; and Georgia Roberson, South Carolina. Mardel Crandell is the author.

Special acknowledgment is given to the General Aviation Manufacturers Association for financial support of the 4-H Aerospace Program and to Estes Industries for their consultation and art work for this publication.

---

**AGRICULTURAL EXTENSION SERVICE ■ UNIVERSITY OF MINNESOTA**

# MODEL ROCKETRY



You've probably built models. Perhaps you started by folding paper airplanes, or making model cars. You're probably ready to try a new challenge — model rocketry. (For another aerospace project, refer to the 4-II members guide for model airplanes.)

Model rockets offer much adventure for you. These models actually fly at more than 300 miles an hour, and they may soar up to 2,000 feet in the air. And they are inexpensive, fun to build, and exciting to launch.

More than that, model rockets can launch you toward an exciting, space-age career. Many model rocketeers become scientists, engineers, and mathematicians.

You can become a model rocket builder if you follow scientific principles, follow the safety code, and follow directions.

## A SPACE-AGE HOBBY?

The "space age" arrived in 1957 when the Soviet Union launched Sputnik I. Since that time, the number of model rocketeers has increased constantly. So, model rocketry usually is thought of as a space-age hobby.

But actually, interest in space dates back more than 4,000 years. Early man studied stars, made a calendar, and even wrote stories about trips to the moon. Then, in 1926, the first liquid-fueled rocket was launched.

That first rocketeer was Robert Goddard. Today, he is joined by thousands of workers in the United States space industry. Maybe you will be part of that industry someday, too.

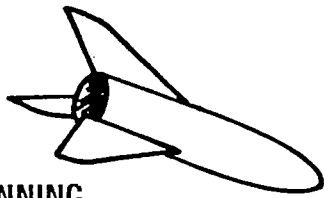

## AT THE BEGINNING

Let's start at the beginning — constructing your own model rocket. Before you can start gluing, you have several decisions to make. First, you must decide which model to build. Some models are display models; some can be launched. Some models are complex; others are easy enough for a beginner. Start with a simple single stage rocket.

You also will have to decide what type of engine you can safely use in your rocket. Some models call for a small "A" or "1/2A" engine, while others call for larger "C" or "D" engines. The single stage model flies on one spurt from the engine. In the multi-stage rocket, the type used in large space vehicles, the engine thrusts at various times in flight, sending the rocket higher.

You also will need to decide how much help you will need to build your rocket. The kits, available at hobby shops, or through mail-order houses, include everything you will need from instructions and materials to paint and decals. Ask your 4-H leader for a mail-order catalog or write to:

Estes Industries  
 Box 227  
 Penrose, Colorado 81240 or  
 Centuri Engineering Company  
 P.O. 1988  
 Phoenix, Arizona 85001

The important thing to remember is to build your rocket out of paper, wood, or plastic. Never use large metal parts. Metal parts can act like bullets if the engine explodes. Boys and girls have been killed because they used metal tubes for their rocket bodies. Model rocketry has an excellent safety record. It is up to you to help keep it that way.

## DESIGNS UNLIMITED

Rockets come in all sizes, from the tiny model to the giant manned space vehicles. There are other differences, too. Some design differences can be seen from the outside; others are inside the rocket body. Before you build a rocket, you should be aware of the many possibilities.

**BODY TUBES** are available in many sizes from your hobby dealer. The long cylinders can be made at home. Experienced model builders custom make their body tubes from a sheet of paper rolled around a rod and glued.

**NOSE CONES**, too, can be purchased or built according to your own design. Balsa wood is the best material for nose cones because it is light and easy to carve. Don't forget that metal is dangerous. Another safety rule to remember is that rounded cones are safer than pointed ones. Besides, rounded cones will perform better at model rocket speeds.

**FINS** come in many shapes and sizes, too. Generally, they should be as large as possible and be securely glued to the rocket body. The ideal material for fins is sheet balsa.

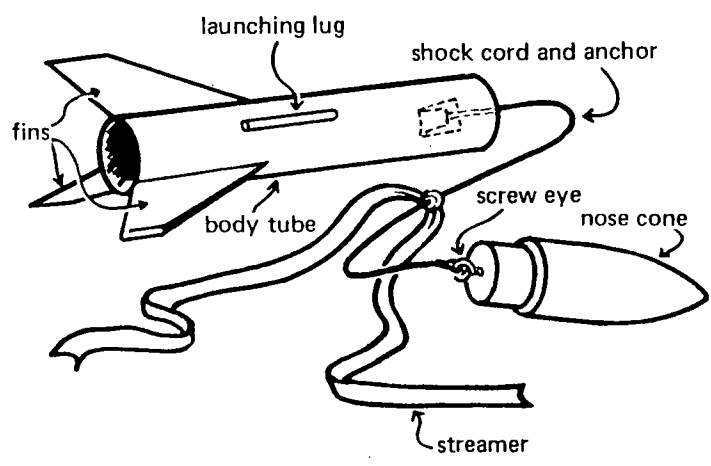

**RECOVERY SYSTEMS** also vary from rocket to rocket. There are six main systems, each designed to return your rocket safely to earth:

• **Featherweight:** When the engine is ejected from a lightweight model, the rocket lands safely because it is so light compared to its size.

• **Tumble:** The rocket with this recovery system tumbles slowly to earth when the ejection charge of the engine unbalances the rocket.

• **Streamer:** A streamer is ejected to slow the rocket on its trip back to earth.

• **Parachute:** A parachute is ejected to support the rocket on its return to the earth.

**Surgeons Strive to Save Life of Victim**

**Boy, 4, Injured As Home-Made Rocket Explodes**

**Boy Injured Friday By Homemade Rocket Explosion**

**Rocket explodes; boy hurt**

**Experimental Rocket Fuel Injures Youth**

**Boy, 4, Injured As Home-Made Rocket Explodes**

**Boy Injured Friday By Homemade Rocket Explosion**

**Rocket explodes; boy hurt**

**Experimental Rocket Fuel Injures Youth**

**Surgeons Strive to Save Life of Victim**

•Helicopter: Vanes on the rocket cause it to slowly spin to the ground.

•Glide: Wings on these models cause the rocket to glide down.

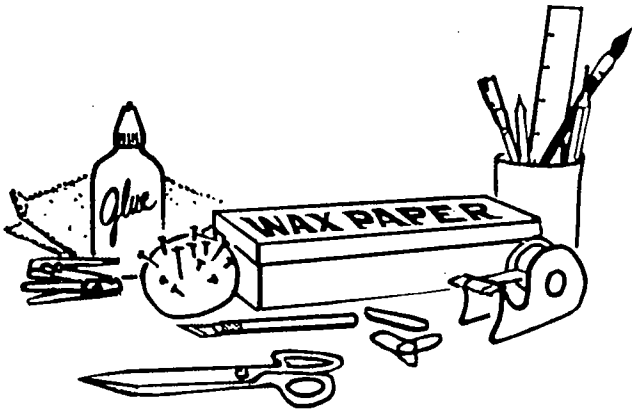

## OUT COME THE TOOLS

Now that you are familiar with the main parts of the rocket, you are ready to go to work. Good workmen, whether they are working on a model or a real spacecraft, find it easier to gather their materials around them before they begin to work. You will find these tools helpful: pins, waxpaper, rubber bands, glue, pincher-type clothespins, pliers, hobby knife, scissors, pencil, sandpaper, file, ruler, and tape.

If you are a beginner, follow the instructions carefully. As you gain experience, you may want to experiment with variations. It is a good idea to protect your plans and instructions by placing a piece of waxed paper over them. Be sure to cover the work area to protect the table.

## SPECIAL HELPS

Although instructions will vary from rocket to rocket, there are certain construction techniques helpful in building any rocket.

### Mounting the Engine

Something must keep the engine in its place inside the rocket body. In some models, a ring called the "engine block" will keep the engine from traveling forward. Use a stick or paint brush to glue the ring inside the tube. If you use the brush, make sure you clean the glue from the bristles before the glue dries.

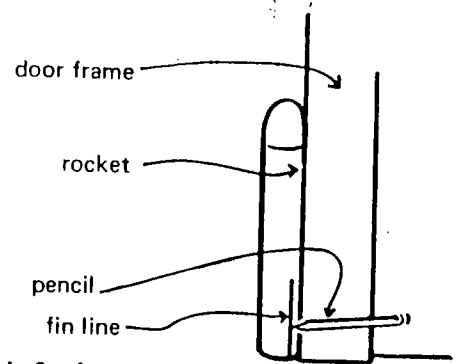
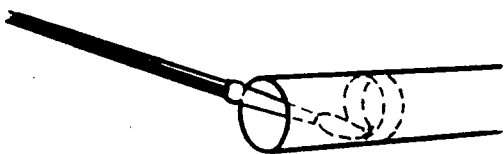

### Mounting the Shock Cord

Remember to use plenty of glue when you mount the shock cord. The cord must be firmly attached. The directions will give you the details.

### Marking the Body

Marking guidelines on the rocket body will help you glue the fins in the right place. Some kits include marking guides which can be cut out. Use a pencil to mark the fin position on the body tube.

### Making the Fins

Your directions will have a fin pattern designed for the model you are making. It is a good idea to make a heavier pattern out of cardboard. To do this, cut out your pattern, place it on lightweight cardboard, and draw around the edges. Cut out the cardboard pattern, and use it to trace your fins on a thin sheet of balsa. Be sure that the grain lines of the balsa wood run parallel to the leading edge of the fin.

To cut the fin, lay a metal ruler along the pattern lines and cut with a hobby knife. Cutting takes practice.

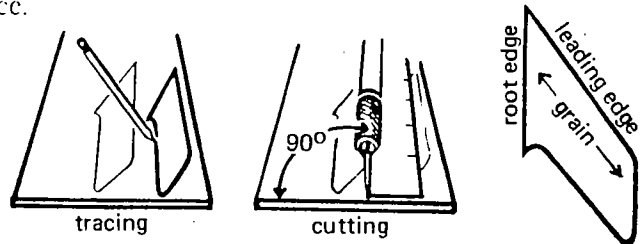

Round all the edges of the fin with sandpaper except for the edge that will be glued to the rocket body. Sanding is important on high performance rockets.

### Attaching the Fins

Use white glue to attach the fins along the guidelines on the rocket body. Put the glue on the root edge (the edge that will be next to the rocket body) and let it set for a minute. Attach the fins to the body so that they stick straight out from the rocket. If the fins tilt, the rocket might wobble in flight or even crash.

Fins should dry with the rocket in a vertical position, fins sticking up. After the glue is dry, reinforce

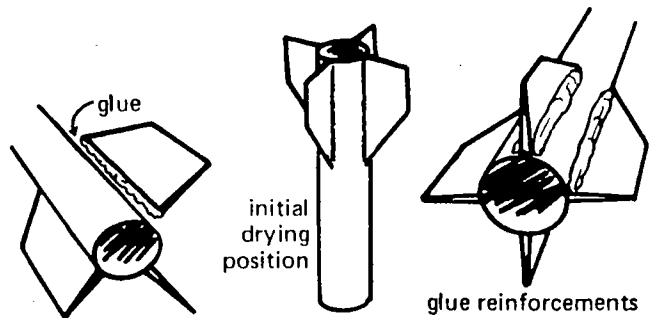

your work by applying a line of glue at each joint. Let this glue dry with the rocket in a laying-down position.

### Making a Parachute

Models with parachute recovery systems often come with their own parachutes. You might like to make a pattern of your parachute in case you need a new one. You can replace your parachute by using plastic sheeting and fishing cord.

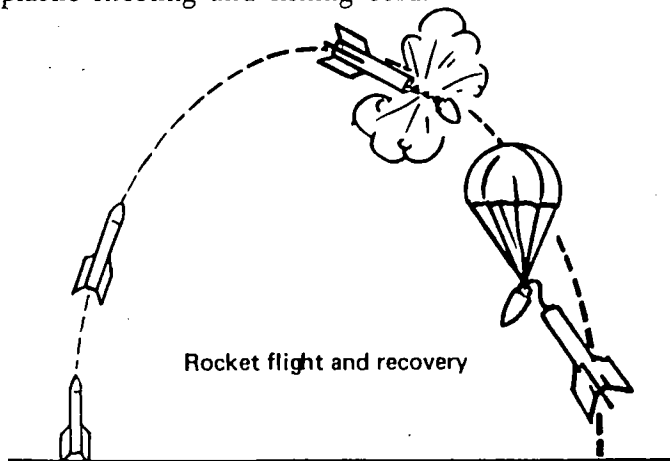

### THOSE FINISHING TOUCHES

Rocketeers like to paint their models. Paint helps them spot their rockets in the air and improves the rocket's looks on the ground. But don't expect a paint job to work wonders. No amount of paint will cover up some mistakes.

Sanding and sealing is the first step in painting. Model rocket materials soak up paint unless they have been sealed. Sand the rocket with extra fine sandpaper and cover it with a light coat of sealer. When the sealer has dried, sand most of it off and apply a second coat of sealer. Repeat until the surfaces are smooth. Be especially sure that the balsa wood surfaces are well sealed and sanded before painting.

Now you are ready to paint. The base coat comes first. Usually, the base coat is white or another light color. Apply a thin coat of paint and set the model aside to dry. When the paint has dried, sand and wipe the dust away with a slightly damp, clean cloth. Repeat until the model has the finish you want.

Butyrate dope is a good paint for brush application. Enamel paints are easily and rapidly applied using pressure spray cans. Never apply dope over enamel paint.

The paint should dry overnight before you add any decals. Follow the instructions that come with the decals. You also can decorate your rocket with stripes and bands of decal material or special tape.

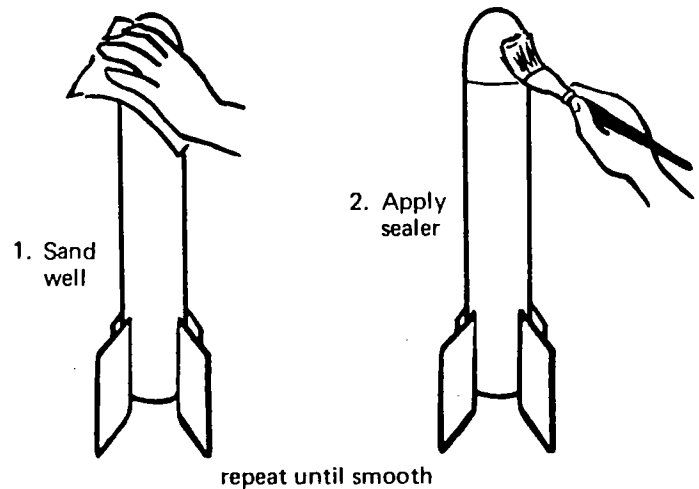

repeat until smooth

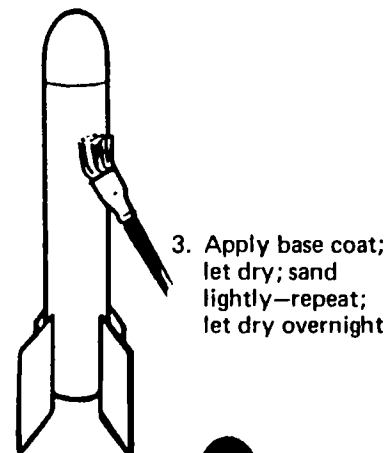

4. Add decals, paint, or tape

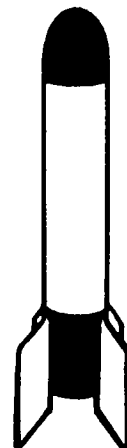

## UP IT GOES . . .

You will use the same principles to fly your rocket that scientists use to send men to the moon. Of course, flying a model rocket is not as difficult as a manned space shot, but it can be just as exciting for you!

Your rocket kit will provide detailed instructions on preparing your rocket for flight. All rocketeers — whether model rocketeers or professionals — must follow instructions carefully. Not only is it essential to the flight of the rocket, but it is essential to the safety of the rocketeer.

Follow your directions and pack recovery wadding into the body tube from the nose cone end. The wadding helps protect the recovery system from the heat of the engine. Special flameproof paper is available.

The instructions also will show you how to fold your recovery system into the rocket body and put the nose cone in place.

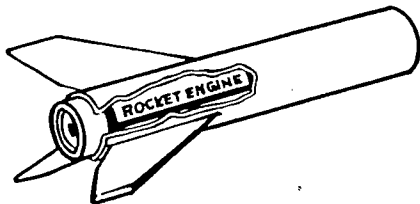
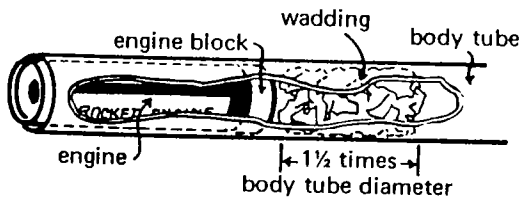

## THE ENGINES

The next step is the engine, the driving force for your rocket. Engines can be dangerous or safe — it depends upon you. Buy commercially manufactured, solid propellant engines. The engines are inexpensive and easy to use. Homemade engines may be very dangerous because the wrong chemical mixtures can cause serious accidents. **ALWAYS BUY COMMERCIALY-MADE ENGINES!!**

The engine you buy looks like a thick paper tube. Inside, it is a powerhouse of fuel. Never cut the tube open, for the chemicals inside could hurt you. If you want to see what the inside looks like, you can order an inexpensive cutaway engine. It is cut open and covered with plastic for your protection.

Engines come in many sizes. The hobby dealer can help you select the right engine for the model you are building.

Instructions come with the engines. Follow them carefully. The directions will tell you how to insert the

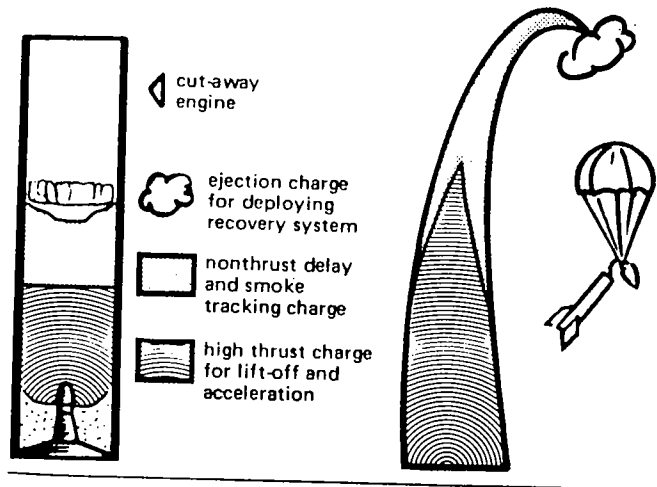

engine into the rocket to make sure the engine fits snugly. The instructions also will tell you how to insert a nichrome wire igniter into the ceramic plug at the nozzle end of the engine. When you launch your rocket, the igniter will become hot.

The heat ignites the propellant in the engine. The solid propellant in this section produces thrust to get the rocket off the ground and into the air.

The propellant starts the next part of the engine, the delay element. This element has no thrust. The delay charge gives off smoke so you can see the rocket from the ground.

When the delay charge has burned, the ejection charge ignites. This charge pushes out the recovery system, giving the rocket a safe trip back to earth.

## THE LAUNCH

Now you're ready for the big moment — the send-off! The launch, like other phases of model rocketry, can be dangerous if you do not follow the safety rules. Make your launch safe and exciting.

## TEST FOR STABILITY

Before scientists send a rocket into space, they put it through pretests to make sure it will perform. Model rocketeers do the same with their rockets. You will want to pretest your rocket for stability. A stable rocket will keep its nose pointed in the same direction while flying upward.

To be sure your rocket is stable, make a loop in the end of a string 6 to 10 feet long. Slip the rocket

body, with the engine in place, through the loop, balancing the rocket horizontally. The point at which the rocket is balanced is called the center of gravity. Tape the string to the rocket body at this point.

Now swing the rocket in a circle over your head. If the rocket is stable, it will point forward. You might have to throw the rocket into position to get it to fly straight. An unstable rocket can be made stable by adding a weight to the base of the nose cone. Do not add weight to the tail of the rocket.

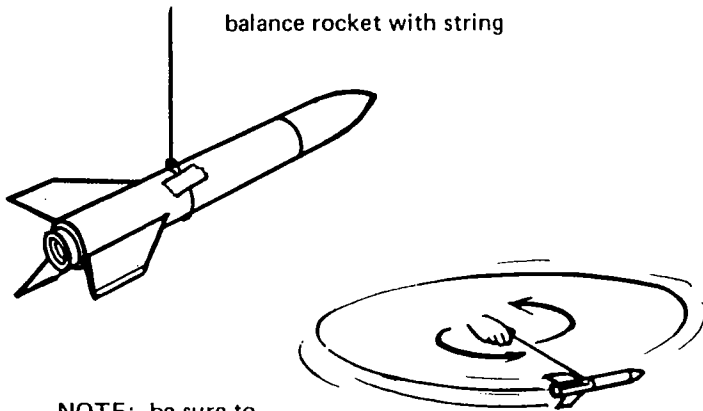

NOTE: be sure to insert rocket engine

If your rocket is stable, it is ready for the launch pad. Remember these safety rules when you launch your rocket:

- Launch rockets only if they have recovery systems.
- Launch rockets upward, never to the side.
- Launch rockets away from tall trees and buildings.
- Launch rockets on calm days, never in high winds.

## LAUNCH PADS

Launch pads can either be homemade or purchased. The most popular pad is a metal rod (1/8-inch in diameter and up to 36 inches tall) set into a wood or plastic base. The rocket attaches to the rod by a launching lug. The lug, a piece of drinking straw, is glued on the outside of the rocket body. The rod guides the rocket into the air.

All model rockets are launched by electric power. You can buy launch pads with the electric power right in the base. If you build your own launcher, you will need another source of electric power. A car battery is a good source. You can use the battery without removing it from the car. Or you can buy a 6- to 12-volt battery at a hardware store.

To build a launcher, you will need:

- 1 battery
- 1 launch rod (as described above)
- 2 battery clips
- 2 micro clips
- 1 spring return launch switch (like a doorbell button)
- 12 feet of 18 gauge, 2 conductor wire
- 1 wood block

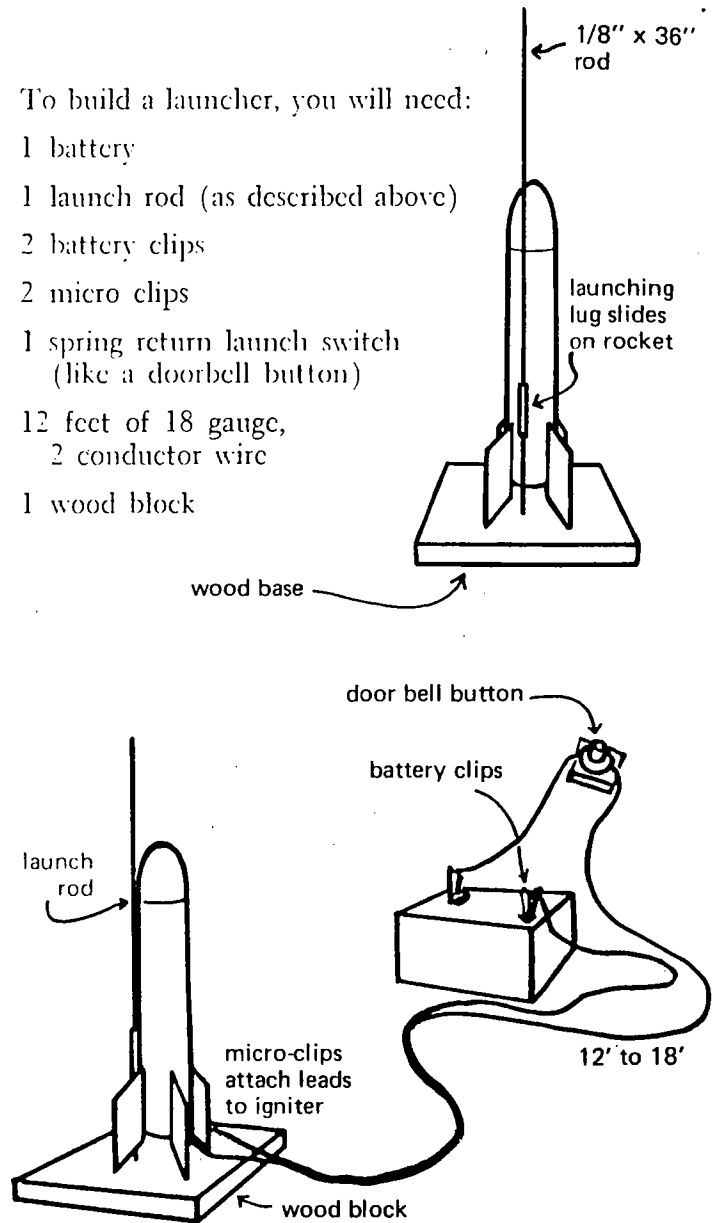

Build the launcher according to the diagram. Before launching, pretest to make sure the launcher will work. To test, **DO NOT PRESS THE SWITCH**. Bring the micro clips together to make sure there is no spark. If there is a spark, recheck your wiring and switch. Disconnect the clips and press the switch. Bring the clips together again. This time there should be a spark. Turn the switch off.

## THE COUNTDOWN . . .

You are ready for the launch. Make sure your electric supply is OFF. Connect the micro clips to the nichrome wire igniter extending from the engine. Clear the launch area, making sure that no one is within 10 feet of the rocket.



It is a good idea to have a countdown, just as professionals do. A countdown will give warning to all spectators and give you time to check for low flying aircraft. Five . . . four . . . three . . . two . . . one . . . and press the switch to launch your rocket. What a thrill to see your rocket zoom into the sky and fall gently back to earth!

### WHAT IF IT DOESN'T FLY?

Once in awhile, your rocket might not go up when you press the switch. If your rocket malfunctions, *turn off the switch and disconnect the battery clips.* Wait a few minutes before inspecting the rocket to find out why it didn't fly. Perhaps you will need to replace a nichrome wire igniter or install a new engine.



## MODEL ROCKET SAFETY

This solid propellant model rocketry safety code is approved by the National Association of Rocketry and the Hobby Industry Association of America.

1. **CONSTRUCTION** — My model rockets will be made of lightweight materials such as paper, wood, plastic, and rubber, without any metal as structural parts.
2. **ENGINES** — I will use only pre-loaded, factory-made model rocket engines in the manner recommended by the manufacturer. I will not change in any way nor attempt to reload these engines.
3. **RECOVERY** — I will always use a recovery system in my model rockets that will return them safely to the ground so that they may be flown again.
4. **WEIGHT LIMITS** — My model rocket will weigh no more than 453 grams (16 ozs.) at liftoff, and the engines will contain no more than 113 grams (4 ozs.) of propellant.
5. **STABILITY** — I will check the stability of my model rockets before their first flight, except when launching models of already proven stability.
6. **LAUNCHING SYSTEM** — The system I use to launch my model rockets must be remotely controlled and electrically operated and will contain a switch that will return to "off" when released. I will remain at least 10 feet away from any rocket that is being launched.
7. **LAUNCH SAFETY** — I will not let anyone approach a model rocket on a launcher until I have made sure that either the safety interlock key has been removed or the battery has been disconnected from my launcher.
8. **FLYING CONDITIONS** — I will not launch my model rocket in high winds, near buildings, power lines, tall trees, low-flying aircraft, or under any conditions that might be dangerous to people or property.
9. **LAUNCH AREA** — My model rockets will always be launched from a cleared area, free of any easy to burn materials, and I will only use non-flammable recovery wadding in my rockets.
10. **JET DEFLECTOR** — My launcher will have a jet deflector device to prevent the engine exhaust from hitting the ground directly.
11. **LAUNCH ROD** — To prevent accidental eye injury, I will always place the launcher so the end of the rod is above eye level or cap the end of the rod

with my hand when approaching it. I will never place my head or body over the launching rod. When my launcher is not in use, I will always store it so that the launch rod is NOT in an upright position.

12. **POWER LINES** — I will never attempt to recover my rocket from a power line or other dangerous places.
13. **LAUNCH TARGETS AND ANGLE** — I will not launch rockets so their flight path will carry them against targets on the ground and will never use an explosive warhead nor a payload that is intended to be flammable. My launching device will always be pointed within 30 degrees of vertical.
14. **PRELAUNCH TEST** — When conducting research activities with unproven designs or methods, I will, when possible, determine their reliability through prelaunch tests. I will conduct launchings of unproven designs in complete isolation from persons not participating in the actual launching.

REVISED 2/4/70

## ROCKETEER'S PLEDGE

I am proud to be a model rocketeer. I feel it is important to do my part in upholding the outstanding safety record that model rocketry has gained. In all my rocketry activities I will act in a mature manner and will always be considerate of other people and property rights. I pledge to follow the Rocketeer's Code of Safety.

## WHAT MADE IT FLY?

Many things helped your rocket fly. You helped it by building it carefully and following the safety rules.

**THE ENGINE** helped it fly by giving the rocket thrust. As the first section of the engine burned, hot gas escaped from the ceramic nozzle, making the rocket move much like a balloon moves when air is released.

Thrust gave the rocket lift. As the rocket lifted, it pushed against the air. The air helped stabilize the rocket, and it also slowed the rocket down. Because the air slows the craft down, this is called drag.

It is the engine's job to overcome the weight of the rocket (gravity) and the air drag. When the engine functions, the rocket flies.

## **WHAT A HOBBY!**

You have discovered the excitement of model rocketry. But don't think this hobby stops with excitement. Model rocketry is a stepping stone to scientific careers.

Perhaps you will work on rockets that will make scientific discoveries or will make our everyday lives more comfortable. Already rockets have sent up satellites that help us make telephone calls across the ocean, predict weather, and see television shows from around the world.

Rockets are a military asset, too. They help defend our country. Rockets also lift man out of his environment to explore new surroundings. We have landed on the moon. Who knows what will be next?

But even if you do not grow up to be a scientist or to work in the space industry, model rocketry has much to offer. It is a hobby the whole family can enjoy. In fact, involving Mom and Dad can make rocketry more fun for you. Your parents can help you learn how the rocket works. Chances are they will learn new things, too.

## **PROJECT CLUBS**

Meeting with other boys and girls who build model rockets in project groups will help you all learn together. And rockets make competing fun. Whose rocket will stay up the longest? Whose flies highest? Whose will land closest to the launch pad?

Many model rocketeers discover that their hobby helps them understand scientific subjects in school. Maybe your grades will go up, too.

## **HAPPY ROCKETING!**

Have a good time as you learn about model rockets. You will soon be designing or modifying your own rockets.

Just remember, **SAFETY COMES FIRST!**

**Always Follow the Safety Rules!**

---

The 4-H Aerospace Program is conducted by the Cooperative Extension Services of the state land grant universities with U.S. Department of Agriculture cooperating. This publication was produced by the Minnesota Agricultural Extension Service, University of Minnesota, St. Paul, Minnesota 55101.

Mention, by name, of mail order companies is solely for the readers' convenience and does not imply endorsement, nor does failure to mention a company imply criticism by the extension services of state land-grant universities.

1971

