

4H SMALL ENGINES

UNIT II

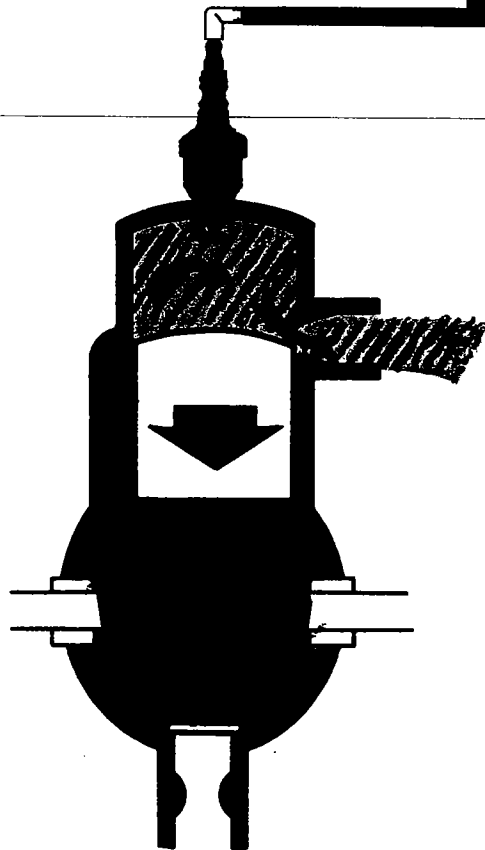

MEMBERS' MANUAL

NAME _____
CLUB _____
BIRTHDATE _____
YEARS IN PROJECT _____
YEARS IN 4-H _____



4-H SMALL ENGINES PROGRAM IDENTIFICATION SHEET

Name _____ Age _____

Address _____

Engine Manufacturer _____

Address _____

Model No. _____ Serial No. _____

Horsepower _____ Engine Application _____

TABLE OF CONTENTS

	Page
Introduction to Two Stroke Engines	3
Principles of Operation of Two Cycle Engines	4
Carburetion	6
Gasoline and Oil	7
Maintenance and Trouble Shooting	8

ACKNOWLEDGMENT

This educational material has been prepared for 4-H use by the National 4-H Petroleum Power Development Committee, composed of representatives of the Cooperative Extension Service of the State Land-Grant Universities, and SEA-Extension, U.S.D.A. in cooperation with the National 4-H Council. Edward O. Eaton, extension agricultural engineer, Cornell University, served as principal author.

Special thanks are extended to Amoco Foundation, Inc. for financial assistance, The McCulloch Corp. and the American Association for Vocational Instructional Materials for technical information and illustrations. This publication is printed and published by the National 4-H Council, 150 N. Wacker Drive, Chicago, Illinois 60606.





4-H SMALL ENGINES PROGRAM INTRODUCTION TO TWO STROKE CYCLE SMALL ENGINES

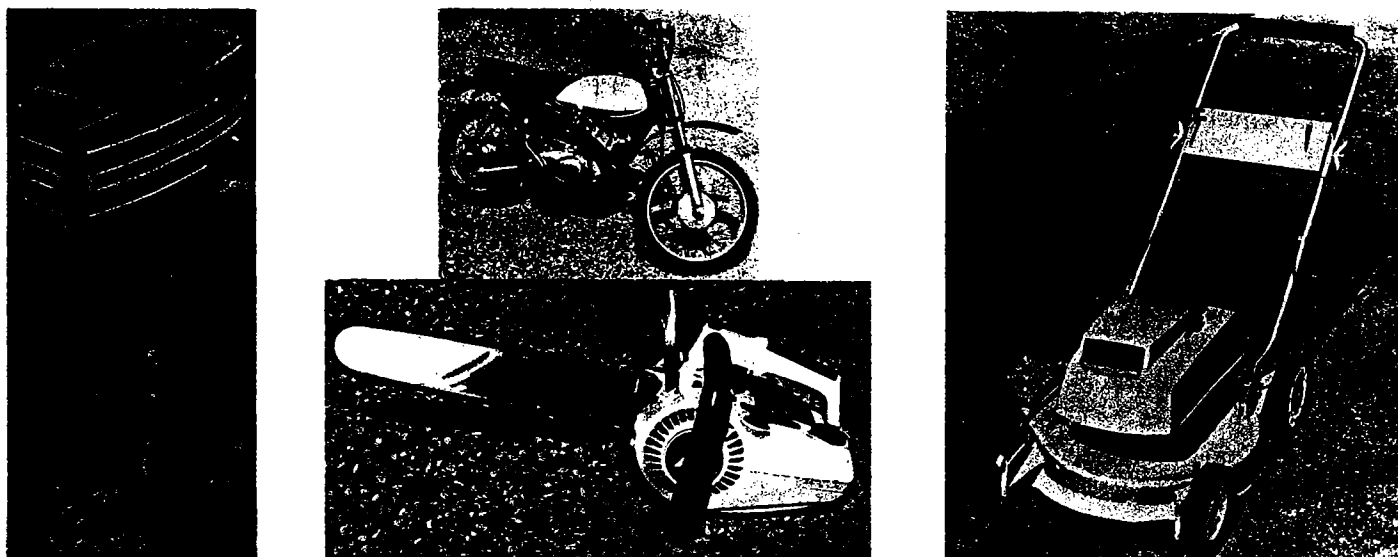

Fig. 1 Two-cycle engine uses.

Your introduction to small engines was probably the project on four-stroke cycle engines. It is best to complete that project before working with two-stroke cycle engines.

checks will help you: 1) look for an oil sump, 2) check the location of the exhaust ports or muffler, 3) check the lubrication instructions, 4) or, if necessary, use the compression method. These checks will make sense to you when you have completed the 4-H Small Engine Program. For example, the two-cycle engine has no oil sump, but gets its lubrication from oil in the gasoline.

It is important that you be able to identify types of small engines because, servicing techniques differ on four and two-cycle engines. Some quick

4 - CYCLE ENGINE

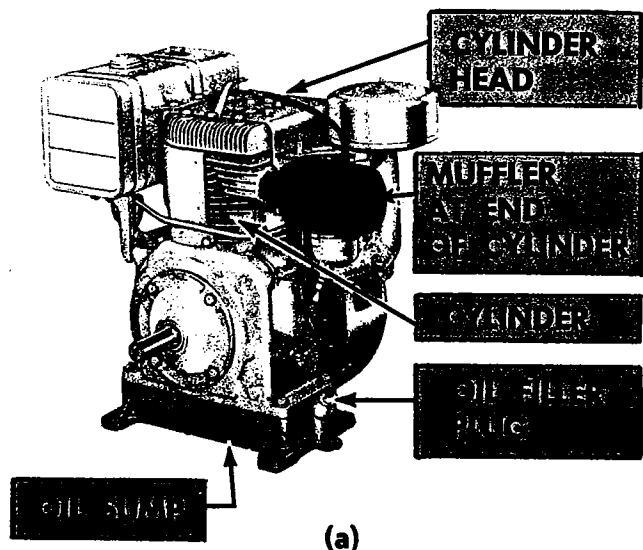

2 - CYCLE ENGINE

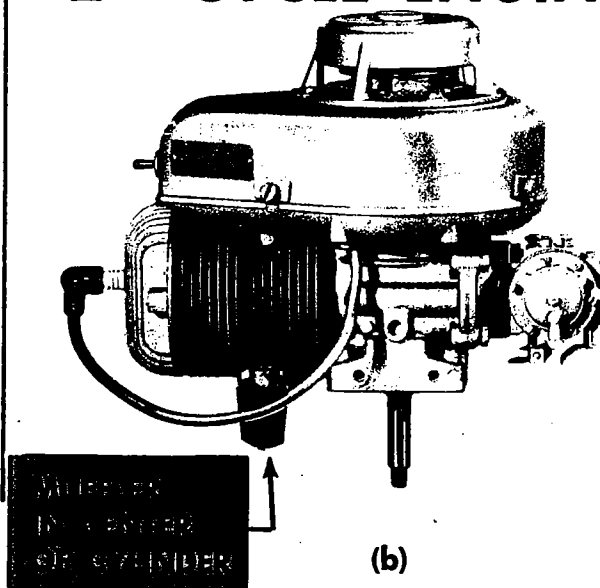

Fig. 2 A comparison of 4 and 2-cycle engines.



The internal combustion engine was invented in 1867 by Nikolaus Otto. Prior to that time, most of the work now performed by engines was done by hand. Otto's engine used the two-stroke cycle and led to a new era of power operation.

Today, the two-stroke cycle engine is used to power lawn mowers, chain saws, outboard engines, snowmobiles and many portable tools. It is

PRINCIPLES OF OPERATION OF TWO-CYCLE ENGINES

A basic knowledge of what makes the internal combustion engine run will make it easier to understand the two-cycle engine. If you first understand the four-cycle engine, it is easier to identify the events which occur as a two-cycle engine operates.

The two-cycle engine uses one power stroke for each complete revolution of the crank shaft. The four-cycle engine uses one power stroke for every other revolution of the crankshaft.

In Unit 1, you learned that each stroke of a four-cycle engine is easy to describe and identify. With a two-cycle engine, the strokes are normally referred to as compression and power. (see Fig. 3-6) Intake and exhaust occur during the power stroke and are sometimes referred to as scavenger events.

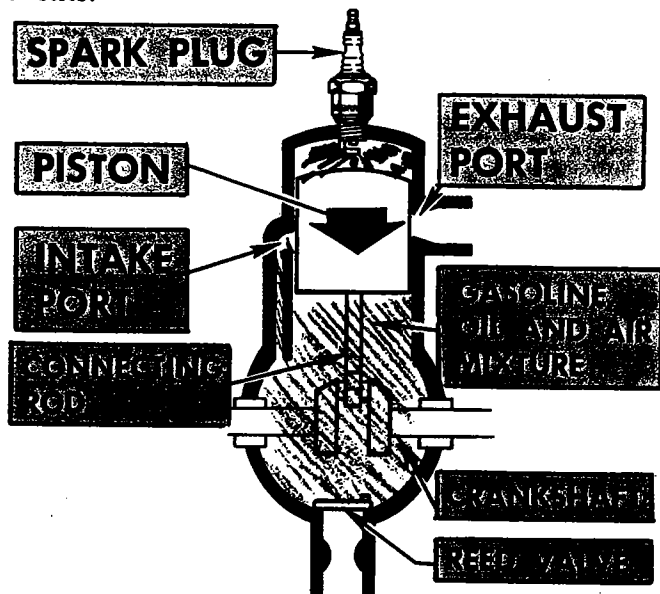

Fig. 3 Stroke 1 — Power

a practical and economical unit with many time and money saving applications.

Activities and Demonstrations

1. Show how to identify a two-cycle from a four-cycle engine.
2. Prepare a list of two-cycle engine applications.
3. Identify the parts of a two-cycle engine.

Piston moves downward under pressure from expanding gases. Reed valve in crankcase closes. (Ignition occurred just before the downward stroke of the piston.)

Stroke 1 - Power

Pressure of the burning gases, caused by the heat of combustion, pushes the piston downward, providing power to turn the crankshaft. As the piston moves away from the head of the cylinder, it uncovers two holes in the cylinder wall, located on opposite sides of the cylinder. These are called ports. One is the exhaust port and the other is the intake port.

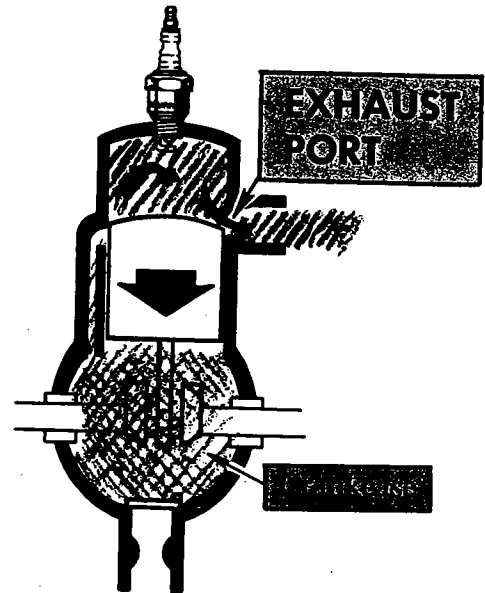

Fig. 4 Stroke 1 — Exhaust

Piston continues to move downward under pressure.

Exhaust port opens.



Stroke 1 - Exhaust

As the piston moves downward, the exhaust port is uncovered first. The burned, hot gases which are under pressure, begin to flow through this port. This occurs on the power stroke.

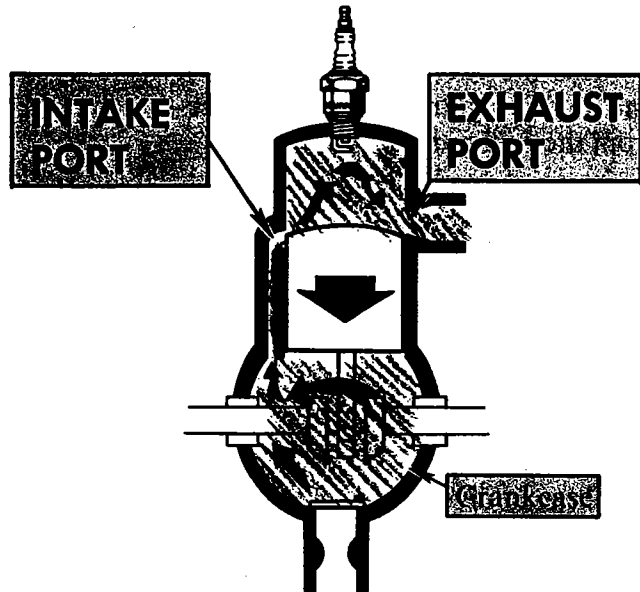

Fig. 5 Stroke 1 — Intake

Intake port opens. Fuel and oil mixture goes into cylinder.

Stroke 1 — Intake

After the uncovering of the exhaust port, the intake or transfer port is uncovered. A fresh charge of the fuel-oil mixture enters the combustion chamber. The charge comes from a sealed crankcase where the mixture has been under slight pressure, developed as a result of the downward movement of the piston. This pressure closes the reed or rotary valve and pressure again builds up in the crankcase.

The crankcase pressure is slight compared to that developed in the combustion chamber. However, it is enough to force a new charge of fuel-air mixture into the combustion chamber. This new charge also helps to force out the remaining exhaust gases. Some mixing of new and old gases occurs, lowering the combustion efficiency of the two-cycle engine.

To reduce this mixing, the top of the piston in two-cycle engines is shaped to act as a barrier between the fresh fuel-air charge and the exhaust gases.

Stroke II - Compression

As the piston moves upward in the compression stroke, both ports in the cylinder are covered and the fuel-air charge is trapped and compressed.

Another event which occurs in the two-cycle engine during the compression stroke is that a new charge of fuel and air is forced into the crankcase. As the piston moves, a partial vacuum is created in the crankcase, atmospheric pressure opens the reed or rotary valve and the fuel-air mixture is permitted to enter the crankcase from the carburetor.

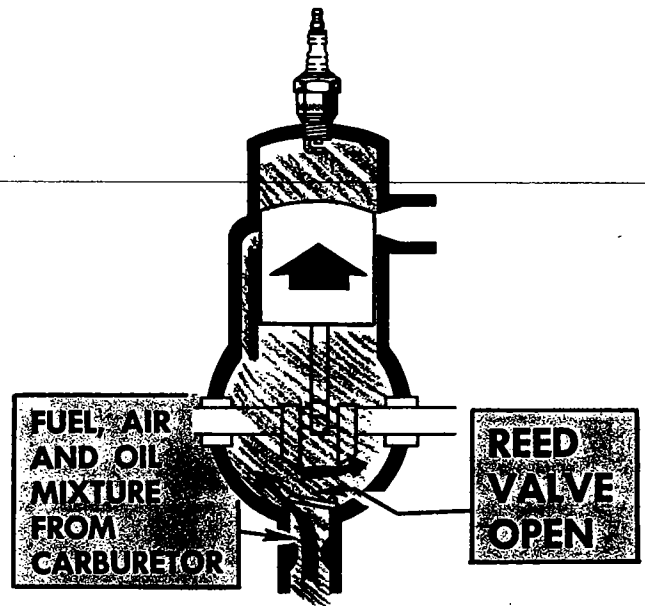

Fig. 6 Stroke II — Compression

Piston moves upward, intake port closes. Exhaust port closes. Reed valve in crankcase opens. Fuel mixture is compressed in the cylinder.

Just before the piston reaches the end of the compression stroke, a spark ignites the mixture and it starts to burn. This begins a new power stroke and another cycle of events.



Activities and Demonstrations

1. Disassemble and study a two-cycle engine.
2. Make a parts display board.
3. Thoroughly clean an engine.
4. Prepare a demonstration of the principles of operation of a two-cycle engine.

CARBURETION

The basic principles of carburetion are the same for the two and four-cycle engines. Refer to your Unit 1, 4-H Small Engine Manual on Four-Cycle Engines for details on the carburetion principles. Remember that it is important to have a combustible fuel-air mixture to make the two-cycle engine run.

Types of Carburetors

Float-type carburetors are used on many two-cycle engines. This type carburetor operates effectively as long as the engine is in a reasonable upright position. However, if turned on its side, or upside down, the float loses all control of the amount of fuel that can enter the carburetor.

The *diaphragm-type* carburetor can be used in any position.

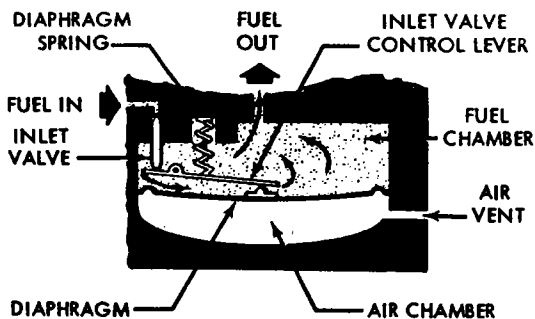

Fig. 7 Schematic of a diaphragm carburetor

It uses a spring loaded diaphragm for regulating the fuel flow into the carburetor fuel chamber. The diaphragm is mounted between the air and fuel chambers and acts as a balancing device. An inlet valve controls the amount of fuel which can be pumped into the fuel chamber. The air is vented to the atmosphere.

In some carburetors, the inlet valve control lever is hooked onto the diaphragm spring to hold the lever against the diaphragm.

When enough fuel has entered the carburetor, the diaphragm moves towards the dry or air chamber and the inlet valve is closed. As fuel is sucked from the chamber, the diaphragm moves towards the fuel chamber, the inlet valve opens and fuel is again allowed to enter the chamber from the fuel pump.

Fuel Pump

Chain saws make use of crankcase pulsation pressures to pump fuel into the carburetor. Most chain saws incorporate the pump as a part of the carburetor.

Like the carburetor diaphragm, the fuel pump diaphragm divides the fuel pump into a wet or fuel chamber and a dry or pulsation chamber.

The pulsation chamber is connected to the crankcase by a passage. When the piston moves up and down, pulsations are transmitted to the fuel pump diaphragm. The outer edge of the diaphragm contains two flapper-type valves which cover the fuel inlet and outlet passages in the pump body.

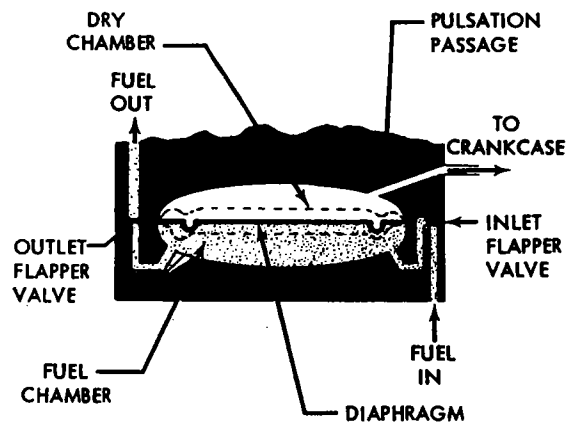

Fig. 8 Fuel pump

When the piston goes up in the cylinder, crankcase suction is transmitted to the dry side of the diaphragm and the diaphragm moves toward the dry chamber, drawing fuel past the inlet flapper valve into the fuel chamber. When the



piston starts downward in the cylinder, the suction is turned to pressure. Pressure in the crankcase forces the diaphragm toward the fuel chamber. The inlet flapper valve is thrust against its seat while the outlet flapper valve is pushed open by the fuel as it moves toward the carburetor inlet valve. At the bottom of the piston stroke, pressure again turns to suction and a new charge of fuel is sucked past the inlet flapper valve into the wet chamber of the fuel pump.

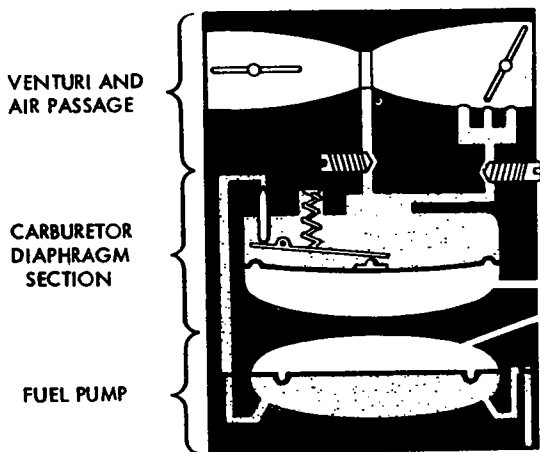

Fig. 9 Diaphragm carburetor and pump

The action of the diaphragm is rapid and a constant supply of fuel is available to the engine.

It should be noted that some engines have no choke, but have what is called a primer. A primer is a type of hand pump with which you can actually pump extra gasoline into the carburetor intake. These are used on most multi-position engines and some vertical and horizontal position engines. This provides a rich fuel-air mixture for starting a cold engine.

GASOLINE AND OIL

Special attention must be given to lubricating the two-cycle engine. The crankcase acts as a transfer pump and lubrication of the engine depends upon the addition of oil to the gasoline. When the fuel-oil mixture passes through the carburetor, the gasoline becomes highly vaporized while the oil is broken into tiny droplets which lubricate all surfaces with which they come in contact.

Preparing Fuel for Two-Cycle Engines

The correct quantity, grade and type of oil, as well as thorough mixing of gasoline and oil before using, are most important.

Use clean, fresh, regular-grade gasoline and use SAE 30, non-detergent crankcase oil unless otherwise directed in your operator's manual or your engine's nameplate.

The amount of oil you mix with the gasoline is critical. For most engines you can mix $\frac{1}{2}$ pint of oil to 1 gallon of gasoline. Recommendations vary, however, from $\frac{1}{4}$ pint to 1 pint per gallon, depending on the engine design, horsepower, size and engine speed. Follow the directions in your operator's manual.

The addition of *more oil than is recommended* will cause poor combustion and the formation of gum, varnishes, and carbon deposits.

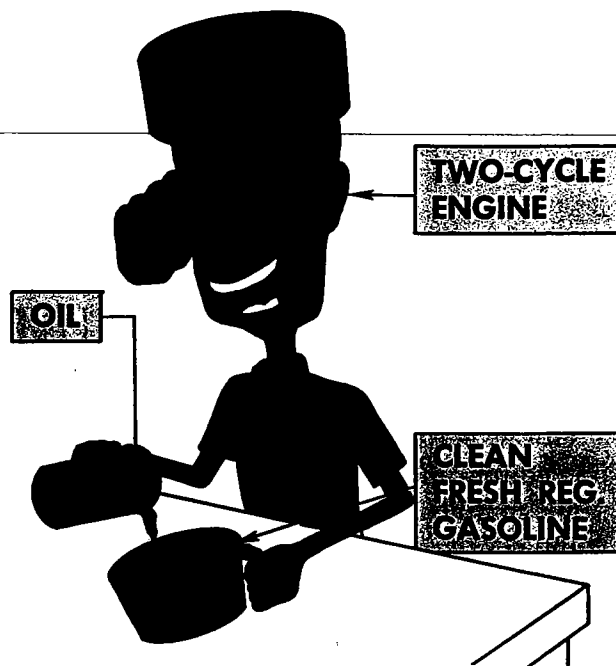

Fig. 10 Two-cycle engines require a mixture of gasoline and oil.

The exhaust ports will become clogged; pre-ignition will occur and the engine will lose power and eventually stop running.

Too little oil may result in inadequate lubrication, greatly increasing wear on moving parts.



The method of mixing oil and gasoline is also important. Once mixed, oil and gasoline do not separate, but they are not easily mixed.

To assure a proper mixture of fuel and oil for your two-cycle engine, proceed as follows:

1. Secure an adequate size enclosed can for mixing. The container should have twice the capacity of the amount of fuel and oil you intend to mix. Make sure it is clean.

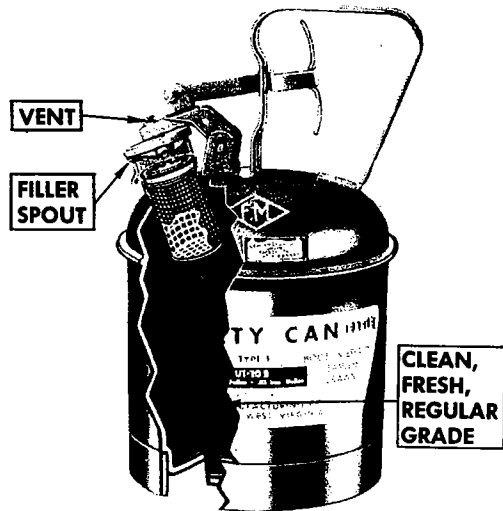

Fig. 11 Gas can construction

2. Fill container $\frac{1}{4}$ full of fuel. If possible, strain the fuel through a clean 120-mesh strainer to remove any trash or dirt.
3. Add the correct amount of oil to the gasoline. Use the oil recommended by your manufacturer.
4. Shake the can vigorously.
5. Add more gasoline until container is $\frac{1}{2}$ full.
6. Shake the can again.
7. Keep can tightly closed and well marked when not in use.

Activities and Demonstrations

1. Discuss a diaphragm carburetor and identify the parts.
2. Start an engine and adjust the carburetor.
3. Explain the functions of the carburetor. Trace the fuel supply from tank to combustion chamber.
4. Demonstrate the proper mixing of fuel and oil for the two cycle engine.
5. What is the purpose of the reed valve in the two cycle engine?

MAINTENANCE AND TROUBLE SHOOTING

Good maintenance and trouble shooting procedures apply to the two-cycle engine in the same manner as the four-cycle. Your owner's manual can supply valuable instructions which should be followed. Remember, it is not normally the fault of the engine when breakdowns occur or trouble shooting is necessary. It is the fault of the operator.

Reportedly, two-cycle engines have more operating problems than four-cycle units. Again, it is usually not the fault of the engine, but the failure of the operator to maintain his machine in the proper manner. Three conditions which may create problems with two-cycle engines, as compared to four-cycle units are:

1. improperly mixed fuel and oil.
2. extended idling periods.
3. dirty operating conditions which are routine for chain saw operators.

How To Locate the Cause of Engine Troubles

CHECK	
●	COMPRESSION
●	IGNITION
●	CARBURETION

Fig. 12 Things to check



The two-cycle gasoline engine must have three things in order to run: correct air-fuel mixture; full compression of the fuel charge and full ignition of the compressed fuel charge. Lack of any one of these will prevent operation of the engine. When the engine doesn't put out full power, or will not run, the things to check are 1) compression, 2) ignition, and 3) carburetion or a combination of these since trouble can strike in several places at once.

Compression

Compression can be checked by pulling the starter rope gently until the greatest engine resistance is felt. Slacken the starter rope and note the amount of engine snap-back. Or, the starter can be pulled and slackened to determine the "bounce" off the high end of the compression. If the point of greatest resistance can't be found, if there is little snap-back or the bounce is below that of the average normal engine, the cause of the trouble can be traced to poor compression.

Compression can also be checked by installing a compression gage in the spark plug hole and pulling the starter rope until the gage needle no longer rises or falls for at least six pulls. The gage should read above 90 pounds pressure for compression to be sufficient for the engine to operate.

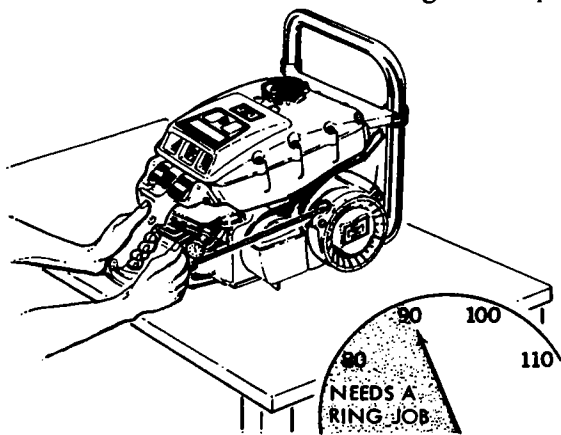

Fig. 13 Compression

Ignition

Ignition can be checked by unscrewing the spark plug from the cylinder head and grounding it by holding the threaded part of the plug against bare metal on the engine. If, when the starter rope is pulled briskly, there is no spark between the

electrodes, replace the spark plug with one known to be good. Ground it on the engine and pull the starter rope again. If there is still no spark, the ignition system is at fault.

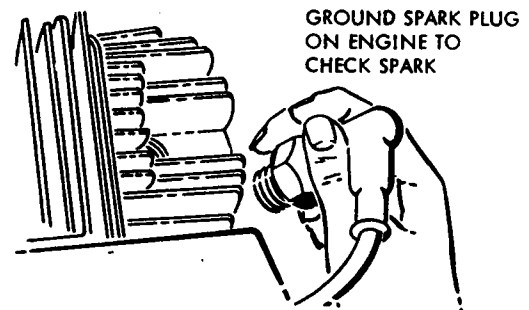

Fig. 14 Ignition

Carburetion

Most carburetor troubles are caused by improper adjustment of the main and idle adjustment needles. Flow of the air-fuel mixture into the combustion chamber can be checked by holding your thumb over the spark plug hole in the cylinder head and pulling the starter rope several times. If your thumb does not become moist with oil and gasoline, the trouble may be caused by an empty tank, a defective reed valve, a pump or by a clogged fuel filter.

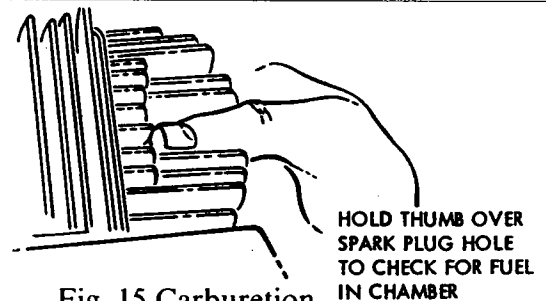

Fig. 15 Carburetion

Maintenance and trouble shooting procedures are more fully covered in the Four-Cycle manual. Good maintenance is easy to learn and trouble shooting is developed by experience. Your 4-H leader or local small engine dealer can be helpful.

Activities and Demonstrations.

1. Demonstrate good maintenance by:
 - a. clean and gap a spark plug
 - b. service an air cleaner
 - c. clean your engine
2. Check for compression, fuel mixture and spark.



Now that you have completed both the four and two-cycle small engine projects, you should be ready to move on to new and even more challenging programs. If you are fortunate enough to live in one of the 36 states and 10 Canadian provinces which lie in the snowbelt, ask your club leader or county agent about the 4-H Snowmobiling Project. This presents an opportunity to learn more about small engines and at the same time participate in North America's fastest growing sport. Another area is lawn and garden care supported by both a members' manual and leaders' guide. There's more too. Other advanced 4-H projects on trail and mini bikes, boat motors and chainsaws are in the planning stages.

INVITATIONAL SMALL ENGINE EVENTS

The small engine projects in which you have been enrolled are part of the 4-H Petroleum Power Program. Each year there are annual regional engineering events in which you might participate. Ask your County Extension Agent about these events.

It can be an exciting experience for you to prepare for one of these regional events. Your preparation should include:

- (1) a knowledge of small engine principles
- (2) parts nomenclature (identify all parts)
- (3) a visual presentation

These engineering events give you a chance to meet new people, visit new places and to have fun.

