

Unit II Member Manual

The WONDERFUL WORLD OF WOOD



Adapted from Wood Science Series

Contents

	Page
Notes to Parents and Home Helpers	3
Introduction	4
Opportunities for Learning	5
Work Safely	6
Trees, Forests and Forest Products	7
Learning to Use Wood	9
Plywood	12
Grid Enlargements	13
Woodworking Tools	14
Steel Tape and Folding Rule	14
Scratch Awl	14
Combination Square	15
Pencil Compass	15
Hand Saws	16
Electric Saws	17
Hand Drill	17
Bit Brace & Auger	18
Electric Drill	18
Wood Screws	19
Screwdriver	20
Oscillating Sander	20
Project Plans	21
Glossary	32

Acknowledgement

This educational material has been prepared for 4-H use by the National 4-H Wood Science Committee composed of representatives of SEA-Extension, U.S. Department of Agriculture and the Cooperative Extension Services of the State Land-Grant Universities. Special thanks are extended to the Weyerhaeuser Company Foundation for financial and technical assistance. This material is published by the National 4-H Council, 7100 Connecticut Avenue, Washington, D. C. 20015.

Programs and educational materials of National 4-H Council; SEA-Extension, United States Department of Agriculture; and all Cooperative Extension Services of the State Land-Grant Universities are available to all persons regardless of race, color, sex, age, religion, national origin or handicap. All are equal opportunity employers.



Note to Parents

and Home Helpers

You as parents and home helpers are the key to your children completing Wood Science Unit II, The Wonderful World of Wood. Even though 4-H leaders help guide and direct your children's work, as parents you should be involved in the planning stages, and also work with your children throughout this project.

Get involved! Make woodworking a family activity. Wood science provides one of the best "learn by doing" opportunities in 4-H. Members have almost an unlimited scope of interesting, educational challenges including designing, constructing and finishing wood. However, in order for them to complete the activities in the wood science units, they need your help.

In Unit II your children will be introduced to power tools, and for safety purposes it is recommended that power tools not be used by children younger than 10 years old, and then only with the supervision of a leader or parent. Leaders can only supervise your children while at meetings so it is up to you to help at home. Make this a safe and enjoyable experience for your children. Help them get the most out of this project by:

- Making this a family project.
- Helping to plan and select woodworking projects that suit your children's ages and abilities.
- Working with them to decide what tools, equipment and supplies will be needed.
- Helping them set goals they can realistically meet so that they don't get frustrated with the project.
- Planning time that you can work with your children on woodworking projects and activities.

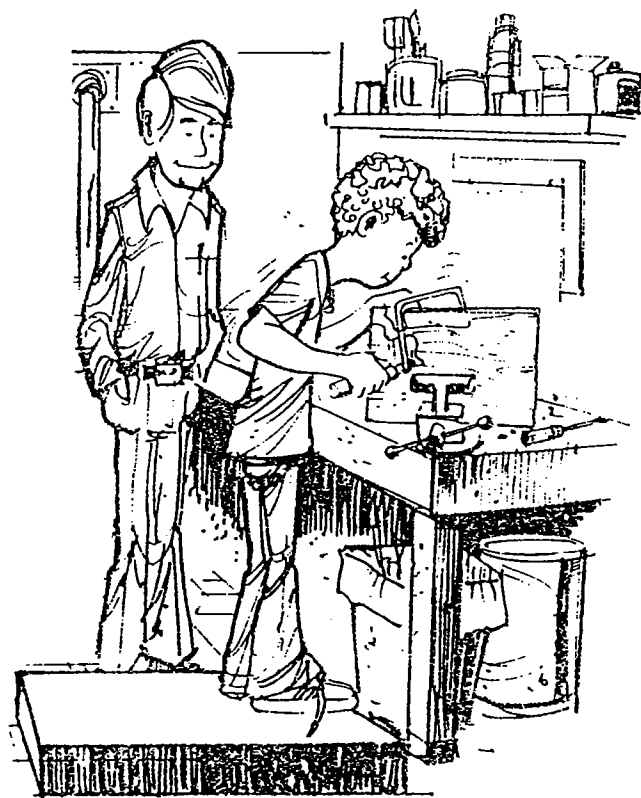

For safety purposes, remember to supervise whenever they are using power tools. Be there to lend a hand, if needed, and to show them that you are interested in the work they are doing but **DON'T DO THE WORK FOR THEM.**

It's a challenging world; **THE WONDERFUL WORLD OF WOOD!**

In Unit II learn to construct "fun" woodworking projects using different tools.

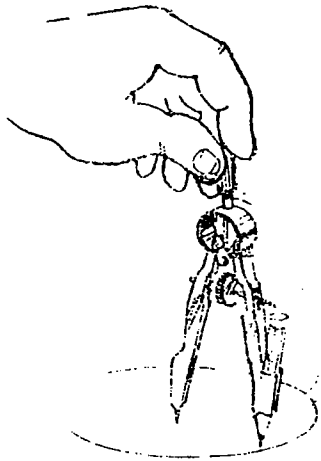

MEASURE AND MARK

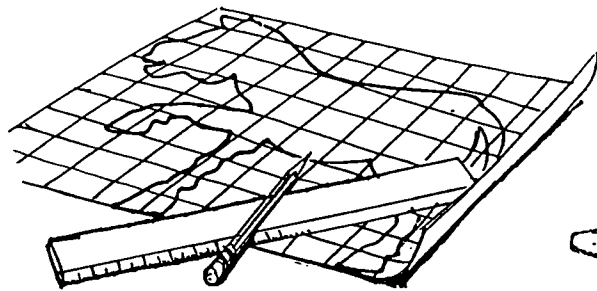

USE A GRID

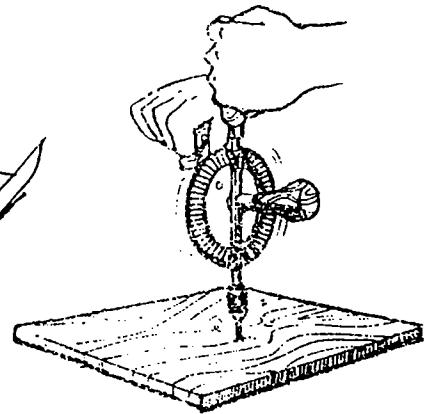

DRILL HOLES

Introduction

Welcome to Unit II of Wood Science, THE WONDERFUL WORLD OF WOOD!

This is the second in the series of 4-H Wood Science manuals. If you have completed Wood Science I, you are probably asking, "now what?" Wood Science can be so interesting and challenging that you never really finish. Making beautiful and useful things of wood is limited only by your interest and imagination.

Unit II and subsequent units will help you continue to grow in your ability to create and assemble items of wood. You will learn more about wood itself; how to identify wood, how to measure wood and how to buy wood.

In the back of this manual are plans for some woodworking items you may wish to make, however, you are also encouraged to make items from other plans. Before you start make sure you can get the necessary materials and make certain that you have, and can use, the right

tools. Ask your parent or leader to help you select a woodworking project that is suited to your ability.

You may do your project work at home, or you may be invited to your leader's home or shop. You will enjoy the project more if you have your own work area in the shop, basement or garage. Be sure to have a place to store your woodworking tools. The tools described in Wood Science Unit I will make a good start on a tool set, and you may also want to add some of the tools that are discussed in this unit.

You will be using some power tools now; an electric drill, sander, saber saw, maybe a jigsaw, and others. These tools are powered by electricity to provide more force so you can do your woodworking jobs more easily and more accurately.

Considering your age and beginning skills, only use power tools when being supervised by a leader or parent. Be sure to read and obey the safety warnings provided by Woody Wise.

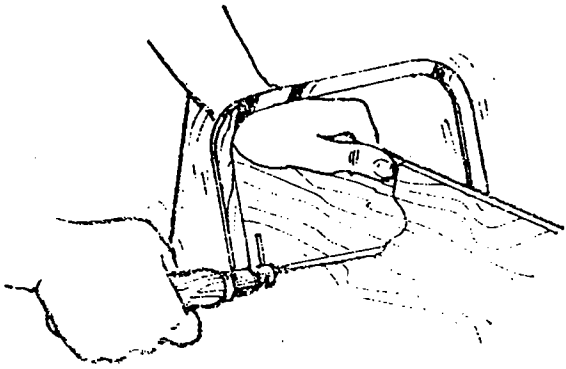

USE DIFFERENT TOOLS



SMOOTH WOOD

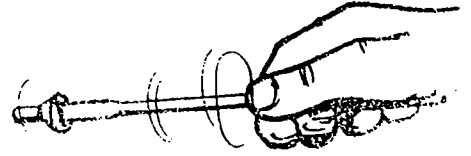

BUILD THINGS

Opportunities for Learning and Doing

In Wood Science there are many different things you can do and things you can make. There are also many opportunities to learn while doing.

A list follows. These are merely suggestions. There may be other things you wish to add. Also, there may be things on the list you may not want to include.

POWER TOOL USERS

1. *Since moisture conducts electricity never use an electric tool in wet or moist conditions.*
2. *Power tools put out quite a lot of force but they can't think! They depend on you to think. So stay alert all the time you are using them.*
3. *Wear safety goggles when driving nails and when using power tools. They protect the eyes from sawdust and chips.*

Woody Wise

1. Make a wooden toy or gift as a Christmas or birthday present.
2. Learn to enlarge irregular shaped drawings using the grid system.
3. Add to your tool set.
4. Build a tool box or storage area for your tools.
5. Start a collection of various sized wood screws.
6. Give a demonstration on the correct use of a hand drill, electric drill or any other wood-working tool. Consider other possible demonstrations that are related to woodworking.
7. Learn the differences between hard and soft woods.
8. Make a list of different jobs that are related to the wood industry.
9. Talk to some of the people who work in those jobs. Find out what they do.
10. Make a list of products obtained from wood. Write a speech or give a club demonstration on products obtained from wood.

Work Safely

1. When working in the shop area wear comfortable clothes. Avoid loose fitting or dangling clothing which might get caught in a machine.
2. Avoid carrying sharp or pointed tools in your pocket. They may cut or scratch you or somebody else, or tear a chair or auto cushion.
3. Be sure every electric tool you use, such as a jig saw, electric drill or sander is double insulated or properly grounded to protect you from electrical shock.
4. All tools which are not marked as double insulated should be properly grounded for protection against electrical shock. This can be done by connecting the tool to the power source with a cable or extension cord that has three conductors. The wire which attaches to the third blade of the plug safely grounds the tool. **This wire is usually green.**

Caution: A three prong plug must always be plugged into a three-hole receptacle.

Many manufacturers are now making portable electric tools with a specially insulated motor and switch housing. Since the housing provides a second layer of insulation to protect the operator it is referred to as "double insulated" and does not require a third wire or prong to ground the tool. These units have a two wire cord and should be identified as "DOUBLE INSULATED" and bear the (UL) label on the unit rather than just on the cord.

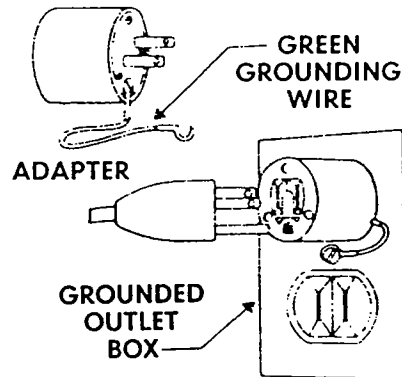

A grounding adapter used with a grounded outlet box.

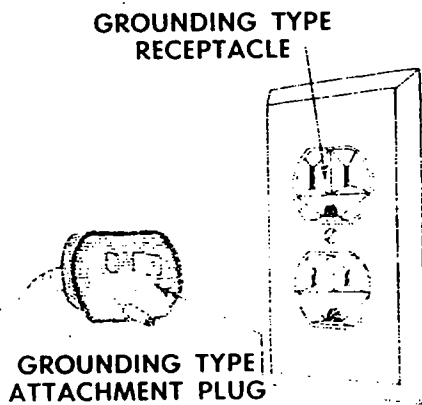

A grounding type attachment plug and grounding type receptacle.

Adapters are available for use with two prong electrical outlets but they should be used with caution. **Only use an adapter if the outlet box is grounded and the green grounding wire is properly attached.** (See figure above.) If the above precautions are followed you can then plug the three prongs of your tool into the adapter and use the tool safely.

Be sure to read your instructions manual before using your power tools. If your manual has been lost, ask your leader or parent for help before using the tool.

Trees, Forests and Forest Products

Take a look around you. No matter where you are — in your home, at school, at church, on a farm or in your yard — you will see wood being used. Wood is an important natural resource and it's renewable.

Since the United States was first colonized billions of board feet of timber have been used to build homes, farm and industry buildings and other wood products, too many to mention. Yet it is estimated that there is still two-thirds as much land in forests as there was when America was discovered.

Trees and forests not only provide wood products for us, they also provide other benefits, such as recreational areas for picnicking, hiking, camping, hunting and fishing. They provide homes and shelter for wildlife. Trees help keep the soil from washing away and protect our valuable water supply. They also help to purify our air and give us fresh, clean air to breathe.

Our forests are called a "multiple-use" resource because they provide so many benefits. Trees, and the wood from trees, are important resources. They provide more than 5,000 beneficial products useful to man. How many ways can you think of in which wood is used? Remember that paper products also come from wood.

Trees must be harvested to obtain wood products. Through proper forest management and harvesting methods, we can have the wood products we need as well as the many other benefits of the forest.

From Trees to Wood Products

The forest products industry is a large and complex industry. Forest resources are converted into usable wood products. This industry is an important part of our nation's economy.

Some regions of our country are almost totally dependent on it for income and employment. About one out of every 20 people who work is employed in some part of the forest products industry. Let's take a look at this industry to see how we get our wood products.

Growing the Timber

The first step in the forest products industry is growing the timber. This is called forestry. Professional foresters manage the forests to increase growth and to protect them from fires, insects and diseases. Keeping forests healthy assures their usefulness to man.

To learn more about our forests and growing timber you may want to enroll in the 4-H forestry project.

Harvesting and Transporting the Timber to the Mills

Harvesting and transporting the timber to the sawmill is the next step in the forest products industry. Harvesting actually involves several steps. Before reaching the mill trees are cut down, limbs are removed, then the trees are cut into logs. This is called harvesting. These steps are sometimes done by one man using a chain saw and a truck. However, large operations employ many persons and use large machines to cut the trees and haul the logs to the mill.

Processing

Processing is the third phase. It is divided into two segments: (1) primary processing, and (2) secondary processing. Primary processing is the sawing, chipping or slicing of the log to

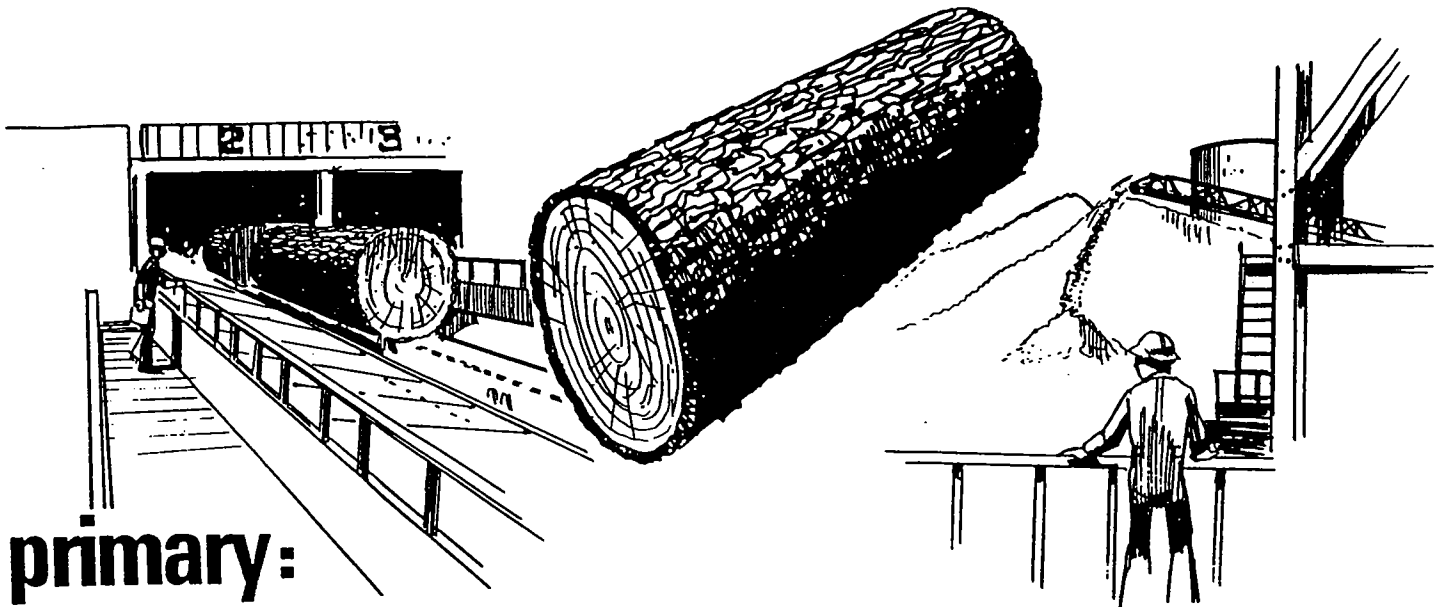

primary:

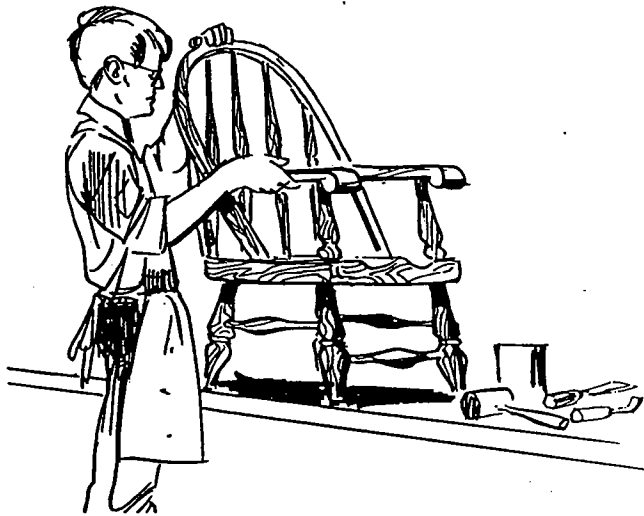

secondary:

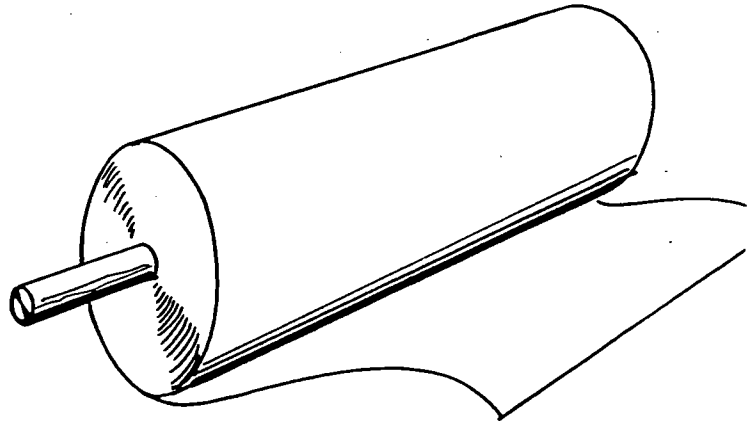

consumer:

convert it into lumber or other raw wood products. Examples of primary processing would be sawmilling to produce pulp and paper, veneer, plywood or particleboard.

Some products need additional manufacturing before use, such as making furniture from lumber, particleboard and plywood. Other examples include producing cardboard boxes or bags from paper, or making flooring from lumber. This is called secondary processing.

Marketing Wood Products

Marketing forest products is also important to the industry. Many individuals handle the

products from manufacturer to user. Much of the lumber is delivered to the lumber yards or building supply stores where customers choose what they need. This is where you may find materials for your woodworking project. Other forest and wood products are sold at commercial and retail outlets, such as office supply stores, furniture stores, hardware stores, etc.

Wood construction and building trades are also part of the forest products industry. Much wood is used in homes and other buildings. Some homes are partially or totally built from lumber in factories while others are built by carpenters on the site.

Learning to Use Wood

How do trees become the wood we use for making things? For some products, the logs can be used almost as they come from the tree. Telephone poles, fence posts and firewood need little manufacturing. For most of the wood we use the logs are cut into lumber or made into plywood, particleboard or fiberboard. The type of tree the wood comes from, how it is cut and how it is treated after cutting will effect how it can be used and even if it can be used for a particular project.

You learned in Unit I that trees can be divided into two basic groups. We call these "hardwood" and "softwood" trees. Hardwoods have broad, flat leaves, like oak, maple and cottonwood. They usually turn colors and lose their leaves in the fall. Softwoods have needle-like or scale-like leaves, such as pine, cedar, and fir, and usually keep their leaves through the entire winter.

These names may fool some people into thinking that the wood from a hardwood tree is always hard, and the wood from a softwood tree is always soft. In fact, this is not always true but the names remain because it is true in many cases.

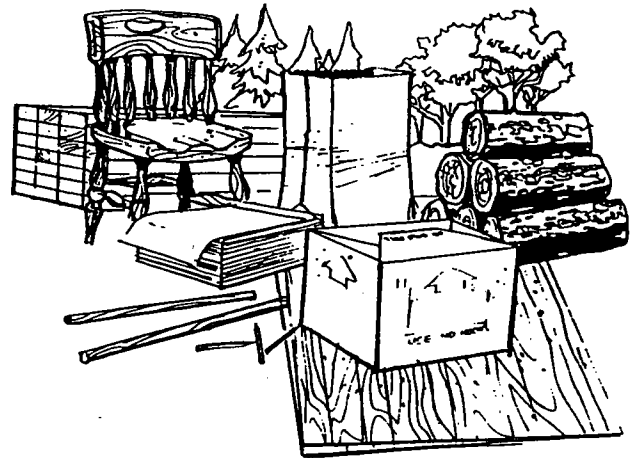

The wood from hardwoods and softwoods are used for different things. Hardwoods are often used to make furniture, flooring and paneling because of the attractive grain and colors. Softwoods are more often used as lumber or plywood for general building construction. For your project, you will probably use softwoods

because they are usually available at local lumber yards. Hardwoods may be harder to find. Discuss with your leader or helper the various woods that are available and have them help you select the best wood to use in your project.

Let's look at wood to see how other things might effect its use. If we look at the cut end of a branch, log or stump we will see rings surrounding the center. They look like a target or bullseye. Each year a tree grows it adds a new ring. This is why they are called "annual rings." You can also see the annual rings on the cut ends of lumber.

Something for You to Do

Find a tree stump, a round piece of firewood or ask your parent or leader to help you cut a piece from the end of a log or tree branch. Count the annual rings to see how old that piece of wood was when it was cut. Remember that the rings go all the way around the trunk so count only from the center to the bark. If the stump or log is old enough, you may even be able to find rings corresponding to some of the important dates in your life, the life of your family or the history of your community. You may want to use annual rings and the history they tell as a demonstration in your 4-H club meeting.

The annual rings not only show on the ends of lumber, but they continue up the length of the board and appear on the faces and sides. They will appear as bands, lines or other patterns. It is these annual rings that give wood its attractive patterns when cut and finished. On the faces and sides of wood we call the annual rings and their patterns the "grain" of the wood. Look at a piece of lumber and see how the annual rings form patterns on the surface.

When a sawmill cuts a log into lumber it may be cut in several ways. If you cut the log off center, closer to the edge like "A," you will get "flat grain" lumber. The grain on the wide face of the board will be large flat bands, long wavy arches or long patches, depending on how the saw cuts through the annual rings of the log. The grain on the edges will be narrow stripes or lines.

If the log is cut through the center like "B" in the drawing you will get "edge grain" lumber. In edge grain lumber the grain goes nearly straight across the board from top to bottom and gives a pattern of stripes or lines on the wide face of the board. Lumber cut near the center of the log will have edge grain.

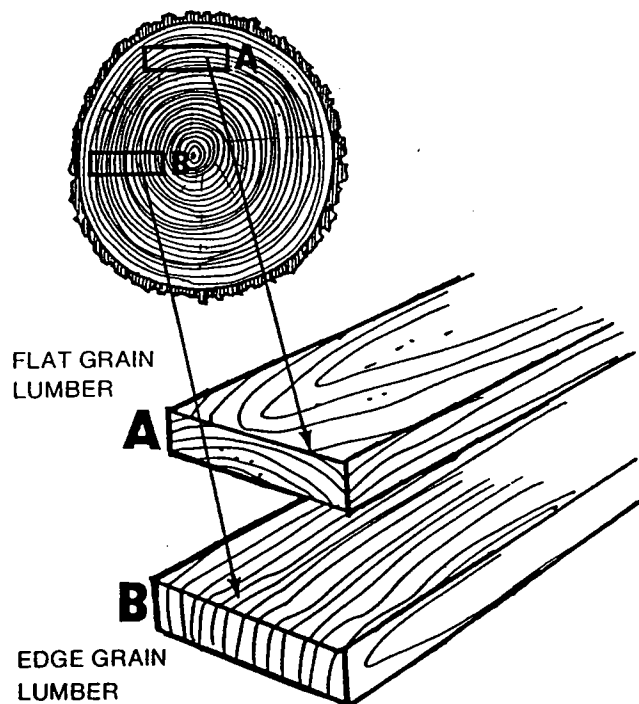

When the lumber is cut from the log it contains a lot of water. Most of this water must be removed by a wood drying process before the wood can be used or the water will eventually evaporate causing the wood to shrink. Some sawmills stack the lumber outdoors to let the water evaporate. This is called air drying and when complete the lumber is called "air dried" lumber. Others will put the lumber in special buildings called dry kilns and heat the lumber to speed drying. Lumber dried like this is called "kiln dried" lumber.

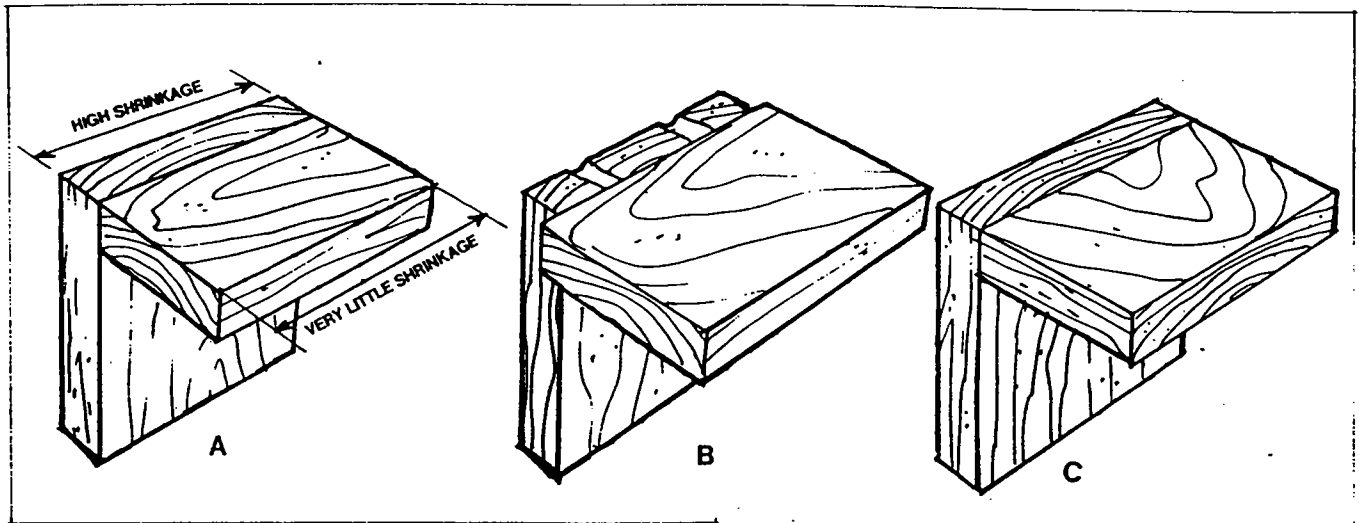

Some of the water in lumber will evaporate without changing the size or shape of the wood. The amount of water that remains in the wood will depend on the temperature and the "relative humidity" of the air around the lumber. Relative humidity is a measure of the moisture that is in the air. If the relative humidity of the air increases, the wood will slowly gain moisture from the air which will cause it to swell. If the relative humidity of the air decreases, the wood will lose moisture to the air and shrink. These changes are always taking place, but if the wood has been dried properly and is protected and used correctly, the changes will be small and should not effect your project.

When wood shrinks and swells the change in size is not the same in all directions. Wood shrinks and swells most in the direction along the annual rings. Along the grain or lengthwise to the piece of lumber shrinkage is very small. Wide and thick boards will shrink more than thin and narrow boards.

When we build projects we must be careful to use wood correctly so that shrinkage and swelling will not hurt our finished product. Pieces put together like "A" (above) end up split and of different sizes like "B" because the wood did not shrink the same amount. The proper way of joining these two pieces is shown in "C." Here the two pieces of wood will shrink and swell about the same.

When wood loses moisture or picks up moisture it may sometimes change shape. This is called "warp." Edge grained lumber will not warp as much as flat grained lumber.

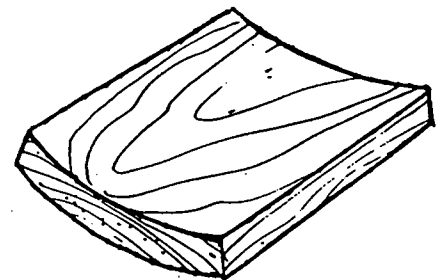

WARP

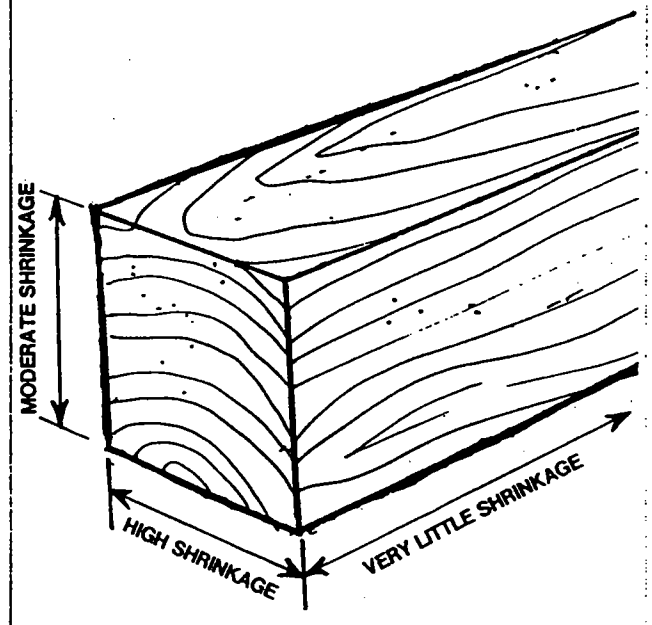

Lumber that has been dried is better to work with than lumber that is "green" or wet because it will not shrink or warp as much as green or wet lumber. Green lumber is lumber that has not been dried.

For projects that will be kept inside a house or building, drier lumber will be needed than if the project is to remain outside. Check with your leader or parent for help.

The size of lumber is called its dimensions or measurements. The dimensions tell you the rough size of lumber when it was originally sawn at the sawmill. A 1 x 4 (one by four) is 1" thick and 4" wide when cut. As you know, lumber shrinks when it dries. Some material is also removed when the wood is planed smooth. As a result, most lumber cut 1" thick will end up being about ¾". A board cut 4" wide will be only 3½" wide after drying and planing. The original sawn size is still used to describe the piece, so it will be called a 1 x 4.

The same thing happens to a 2 x 8 (two by eight). It is 2" thick and 8" wide when sawn. After drying and planing it will be 1½" x 7¼", but it will still be called a 2 x 8.

Plywood

You were introduced to plywood in Unit 1. Plywood is made by gluing together three or more thin layers of wood called *veneer* and laying the grain of each piece at right angles to adjacent pieces. This gives the plywood extra strength and reduces shrinking and swelling.

Plywood is normally sold in sheets 4 feet by 8 feet (4 x 8). It comes in many thicknesses and is measured in inches and sold by thickness. (For example, plywood called ¾" plywood is ¾-inch thick.) Unlike lumber, 1" plywood is one full inch thick.

Plywood is made in two types: (1) exterior type and (2) interior type. The type refers to the glue used between the plies. If your item is going to be used outdoors be sure to get exterior type plywood or the plies will come apart when the plywood gets wet. For indoor use buy interior type plywood because it is less expensive for the same grade surface.

Many different species of trees are used to make plywood. Most of the softwood plywood comes from either Douglas fir or southern pine.

The grades of softwood plywood are based on the quality of the veneer. The standard grades of

veneer are A, B, C and D, with A being the highest grade and D being the lowest. In the lower grade more knots and defects will be present, however, these defects have little effect on strength.

Both sides of the plywood sheets are graded and do not have to be graded the same. If a sheet of plywood is graded A-D, the face will be A grade and the back will be D grade. In this manner we can get greater use out of the high grade logs than we could if all plies were required to be grade A throughout.

Interior plies will usually have D veneer on the inside plies. Exterior plies must have C or better veneer throughout.

If you are building a project where both sides will show, you will want to use an A-A plywood. If only one side will show, you can use A-C or A-D panel. You can sometimes cut pieces with clear faces from lower grade plywood by cutting in between the defects.

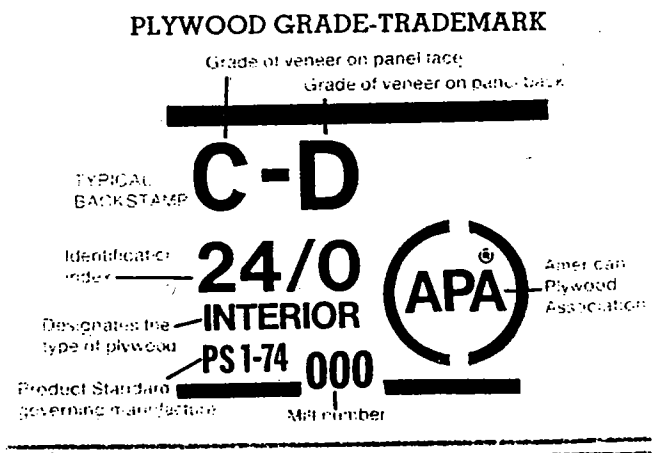

Mill-Certified or Shop Grade Plywood

Some plywood is sold as mill-certified plywood. It may also be called shop plywood or shop cutting panels. This is plywood that has some defects that keep it from being sold as a standard grade. Mill-certified or shop plywood is most often found in areas where plywood is made. This is in the southern and western coast states. It may not be available in areas that are a long way from plywood plants. Mill-certified and shop plywood costs less than standard grade panels. Many good, small pieces of plywood can be cut from mill-certified panels. These can be used for your woodworking projects.

How to Use the Grid System

You may want to learn how to use the grid system to make drawings of irregular shaped articles. The grid system is used to enlarge irregular shaped drawings that are too small for a trace pattern.

For instance, if you had a 2" x 2" drawing of this key hook holder and you wanted to make it larger, you would follow these steps:

1. Decide on the size you want your pattern to be.
2. Draw a grid on your original article, and draw a grid the size you want your pattern to be on a clean piece of paper or wood. Both grids must have an equal number of squares, but the larger the drawing the larger the squares. The new drawing will then be your pattern.
3. Along one side number the lines. Place letters of the alphabet along the other.

Remember, the squares on both grids must be identified the same.

4. Now you are ready to draw. On your original drawing place dots where the outline of the picture crosses the grid lines. Transfer these dots to your new grid pattern plotting the points one by one and connecting them in order as if you were trying to draw the picture free-hand. Use straight lines and curved lines where appropriate. As you connect the dots your new pattern should be the same shape as your original, only larger.
- To make a 12" x 12" drawing, use 12 rows of 1" squares.
 - To make a 16" x 16" drawing, use 16 rows of 1" squares or 8 rows of 2" squares.
 - To make a 24" x 24" drawing, use 24 rows of 1" squares or 16 rows of 1½" squares.

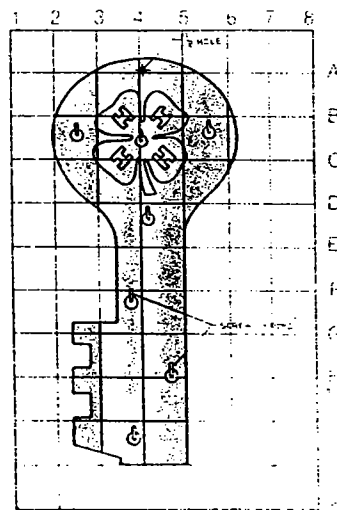

Original Pattern

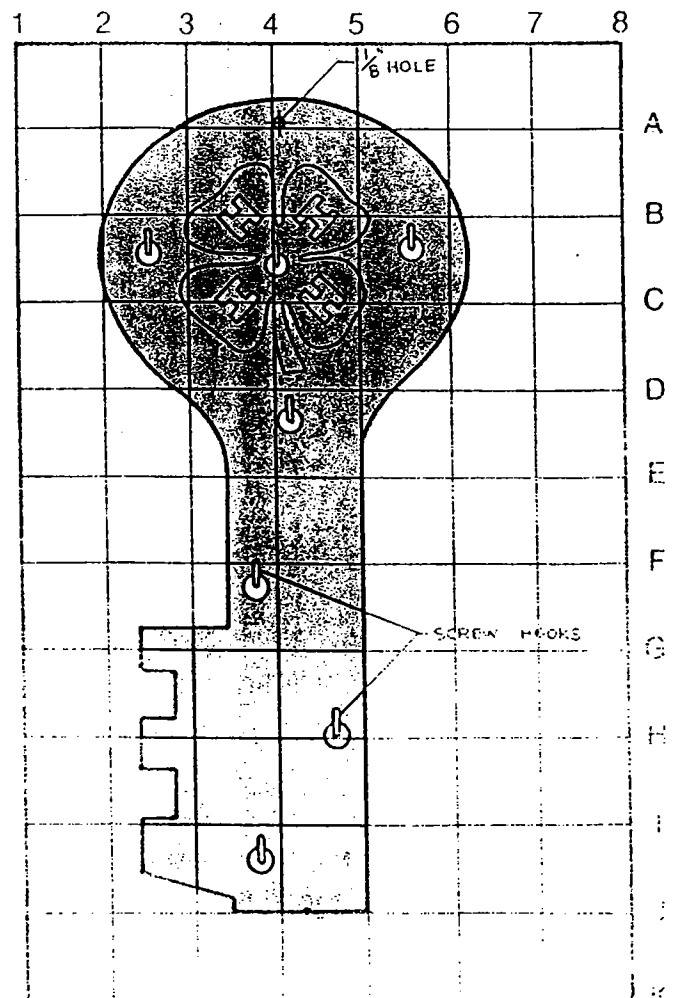

New Enlarged Pattern

Your Tools

Wood Science Unit I contains information about a group of tools and some equipment you should have for your use. This unit contains information about more tools. You may want to add some of them to your tool set.

Steel Tape and Folding Rule

In this unit you will be making bigger things than before. Therefore, you may desire a steel tape rule or a folding rule. Both are available in similar price ranges. For your use, consider the lower cost range and either the steel tape rule or folding rule as suggested by your leader.

The steel tape rule is available in many lengths; 6, 8, 10 and 12 foot lengths. The 6 foot length will probably be adequate for your use.

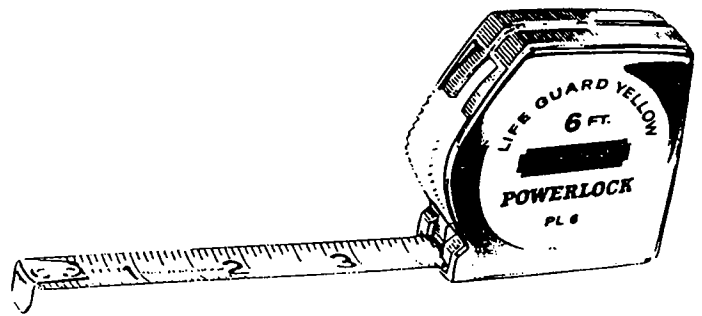

Steel Tape Rule

Scratch Awl

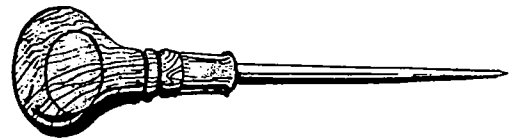

Now that you are doing more exact and accurate work than before, you may need a scratch awl for marking. It gives a very clean, sharp distinct line for accurate cutting. It can be used to make a center point in wood for drilling.

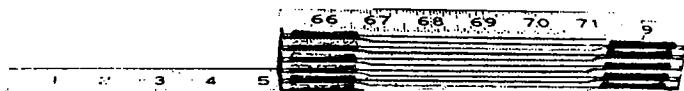

Inside reading rule

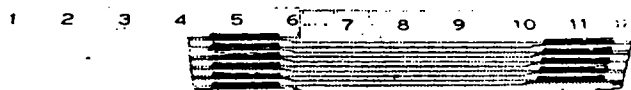

Outside reading rule.

Folding rules are available with either standard inside reading or outside reading. The numbers on the inside reading rule begin on the inside face. Thus the markings are close to the work when the rule lies on the work with the unfolded portion up.

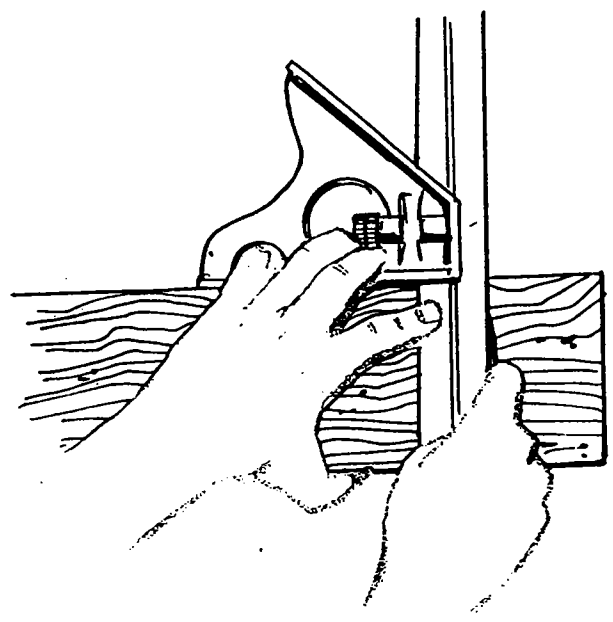

Scratch awl used for marking.

AWL USERS

An awl is sharp-pointed like an ice pick. It is used for marking lines or piercing small holes in wood. Because of its sharpness, it must be handled carefully at all times so it won't pierce your skin.

*A note from
Woody Wise*

Combination Square

A steel combination square and a scratch awl marker or pencil can be used to make a line of uniform distance from one edge of the wood piece.

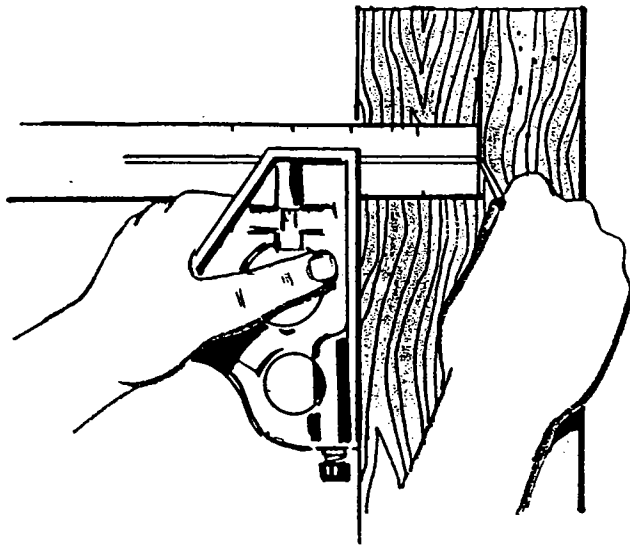

Set the blade of the square in the desired position and securely tighten the adjusting nut. Hold the square firmly against the edge of the wood. Slide the handle along the edge of the wood piece with one hand while marking at the end of the blade with the other hand. Slant or slope the marker in the same direction as you are moving the square.

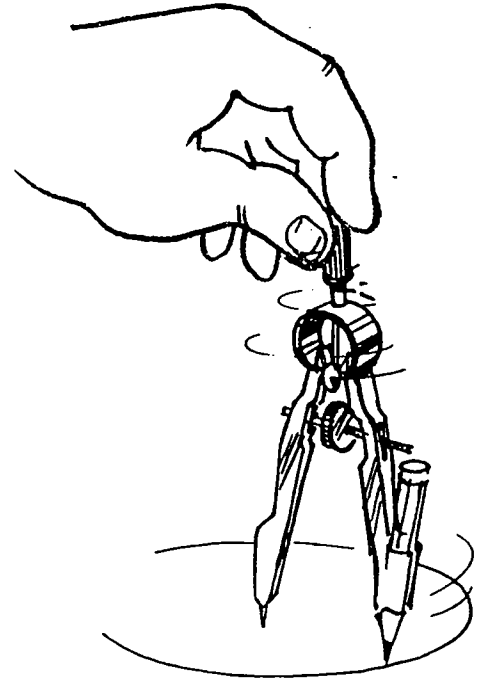

Pencil Compass

A moderately priced pencil compass will work well for drawing circles or parts of circles. The pencil should be adjusted so that when the compass is closed both the pencil point and the needle-like point of the leg are the same length. To use the compass, push the needle-like point into the center spot of your circle and move the compass in a circular motion. Slightly lean the compass in the direction you are moving.

When drawing a circle on a piece of paper, place a piece of cardboard or wood under the paper. Otherwise the needle point may go through the paper and harm a nice tabletop.

Hand Saws

Saw size is determined by the length of the blade in inches. Some popular sizes are 20", 22", 24", and 26". The coarseness or fineness of a saw is determined by the number of teeth points per inch.

There are different types of hand saws, each suited for a particular job.

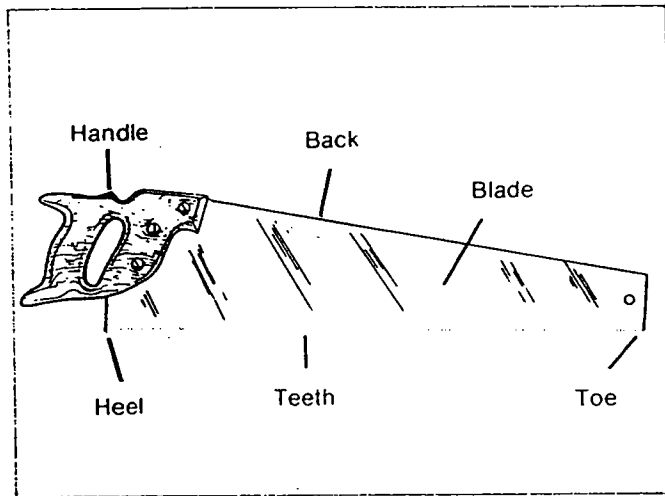

Crosscut Saw

This saw is used frequently by woodworkers. Crosscut saws cut across the grain of wood and they cut on both the forward and backward strokes. They are available with coarse teeth or with fine teeth, and the teeth have knife-like points.

A coarse, crosscut, 8 point saw works well for fast work and for green wood. A fine saw, 10 to 14 teeth points per inch is better for smooth, accurate cutting and for cutting dry wood.

Rip Saw

Rip saw teeth are shaped like chisels. They cut like a gang of chisels in a row. The rip saw cuts mostly on the forward stroke and is used for cutting with the grain of the wood.

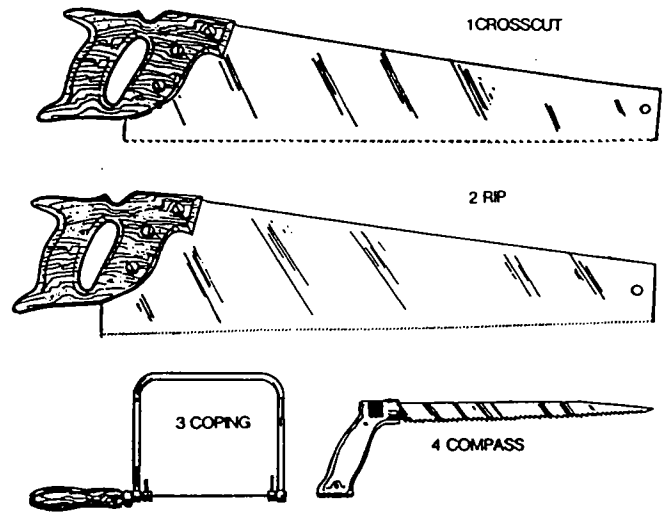

Coping Saw

This saw is commonly used for cutting curves in wood. It is small with a narrow blade and cuts better on wood that is not too thick, like 1/4" to 1" thick. As the saw cuts it tears and breaks the wood fibers, cutting in the direction that the teeth are pointing. For example, if the blade is placed in your saw with the teeth pointing toward the handle, the saw will be cutting on the pull stroke.

Crosscut Saw Teeth



Rip Saw Teeth

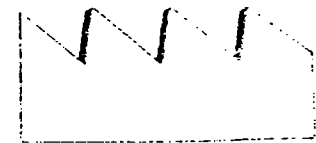

Compass Saw

This saw is small with a short, narrow blade. It is used to saw curves in wood too thick for a coping saw. To start an inside cut with the saw you must bore one or more holes large enough to admit the point of the saw. Insert the saw point in the hole and cut with smooth even strokes.

Power Saws

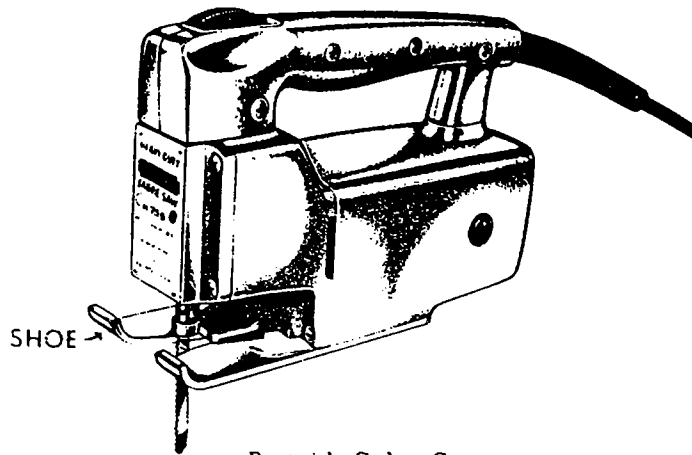

Portable Saber Saw

Saber Saw and Jig Saw

These power saws will cut straight lines, curves, circles and irregular shapes. Blades are available for these saws that can be used to cut metal, plastics, composition board, rubber, etc.

It would take many pages to explain in detail the operations of these saws. If you have one of them, study the instruction book you received. Only operate power saws with the supervision of a leader or parent.

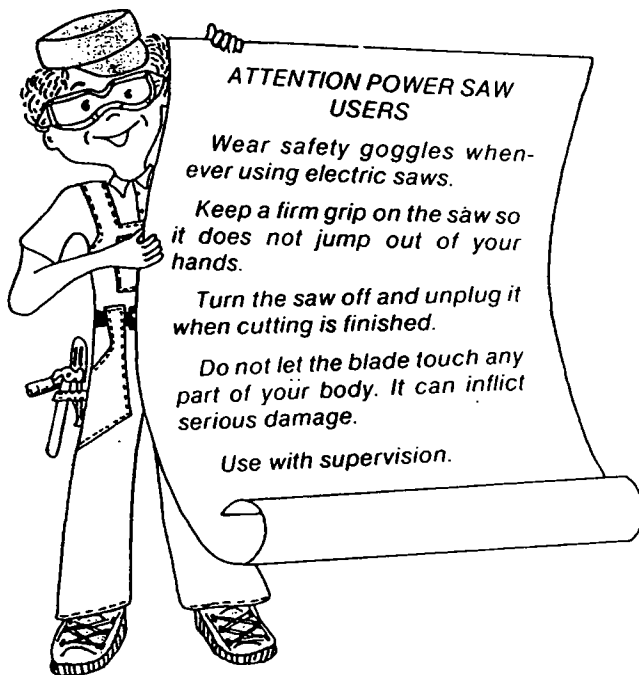

ATTENTION POWER SAW USERS

Wear safety goggles whenever using electric saws.

Keep a firm grip on the saw so it does not jump out of your hands.

Turn the saw off and unplug it when cutting is finished.

Do not let the blade touch any part of your body. It can inflict serious damage.

Use with supervision.

Tools for Boring Holes in Wood

Hand Drill

The hand drill is used with removable drill bits of different sizes. It is used to make small pilot holes up to 1/4" for nails and screws. This prevents splitting the wood. Use it also to drill a starting hole for the coping saw blade.

Before you start drilling, make a small starting hole in the wood with a scratch awl or a nail and hammer. The hole will prevent the drill point from slipping or sliding. Always make sure you have the right size drill bit properly placed in the chuck before you start to work.

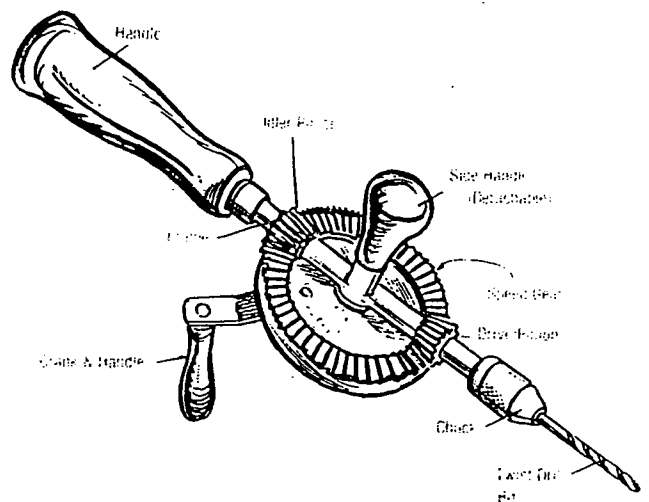

To put the drill bit in the chuck, hold the crank handle and frame with one hand and turn the chuck to the left with the other. Open the jaws only a little more than the size of the drill bit. This helps to center the bit. Turn the chuck back to the right to tighten and hold the bit in place. The drill is used by holding it straight up and down. Hold the handle in your left hand and turn the crank with the right hand.

PROPER USE OF HAND DRILLS

Be careful. The drill may be jerked out of the wood and injure you. The gears can also pinch.

Woody Wise

